

Complementi

Madie/Librerie/Tavoli/Tavolini
Sedute/Complementi e accessori

C

ORME

Complementi

C

La collezione complementi di ORME nasce dall'esperienza e dalla continua ricerca delle esigenze di mercato e dei mood stilistici, una gamma completa per soddisfare le nuove tendenze. La collezione spazia tra svariati elementi d'arredo utili in tutta la casa ed un'ampia gamma di finiture che accontenta sapientemente i gusti più disparati.

The collection of accessories by ORME comes from the experience and the continuous research of market needs and stylistic moods, a complete range to meet new trends.

The collection ranges from various furnishing elements useful throughout the home and a wide range of finishes that expertly satisfy the most diverse tastes.

ORME

INDICE CONTENTS

MADIE - SIDEBARDS	Pag. 4
SYSTEM MODULO	6
VIRGO	18
ROMBO	26
GLASS	30
TRAY	38
CLIO	42
PUNTO 08	46

LIBRERIE - BOOKCASES	Pag. 54
WALL 12	56
GRAFIC	58

TAVOLI - TABLES	Pag. 68
SAMBUCO	70
PINO	74
SLIM	78
LUIS	82

TAVOLIINI - OCCASIONAL TABLES	Pag. 86
SAMBUCO	88
GINESTRA	92
ASTER	94
FRUIT	98
AMARANTO	102
LAMA	104
GLICINE	108
PUZZLE	110

SEDIE e POLTRONA - CHAIRS and ARMCHAIR	Pag. 116
TETRIS	118
DAFNE	122
FANNY	124
TOSCA	128
DIAMANTE	130

COMPLEMENTI e ACCESSORI - COMPLEMENTS and ACCESSORIES	Pag. 132
ALFRED	134
TEKA	136
STREMA	140
GRAFIC	142
LANNY	146
ACCORDO	150
AIR	152
UNIT	156
LULO	160
LIME	162

INFORMAZIONI TECNICHE - TECHNICAL DATA	pag. 164
FINITURE - FINISHES	166

MADIE SIDEBOARDS

Un programma dalle molteplici funzioni, che diventa all'occorrenza madia, credenza o porta tv. Personalizzabile con spessori diversi di ante, conformazioni di facciata infinite e top nei materiali più ricchi come il marmo. Posizionabile su piedini o basamenti di forte carattere. Molteplici misure pensate per tutte le abitudini e le esigenze del vivere quotidiano.

A program with multiple functions, which becomes a sideboard, cupboard or TV stand if necessary. Customisable with different door leaf thickness, infinite front shapes and tops made of the richest materials such as marble. Positionable on feet or strong character bases. Multiple measures designed for all the habits and needs of everyday life.

BASAMENTI / BASES

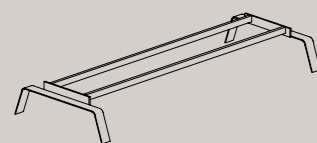

TIGLIO
H 120 - 204 mm
Disponibile per diverse misure
Available in different sizes



KAKO
H 204 mm
Disponibile per diverse misure
Available in different sizes

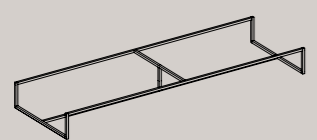

ERICA
L 1200 H 120 - 204 P 420 - 500 mm
L 1800 H 120 - 204 P 420 - 500 mm

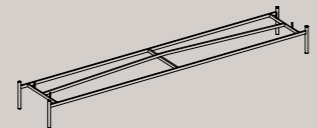

DALIA
L 1200 H 120 - 204 P 420
L 1800 H 120 - 204 P 420
L 2400 H 120 - 204 P 420

SYSTEM MODULO

Pag. 6

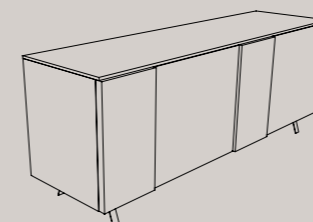

VIRGO

Pag.18

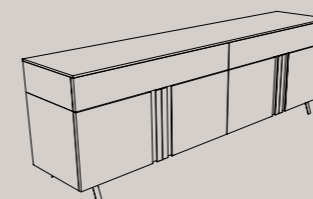

ROMBO

Pag. 26

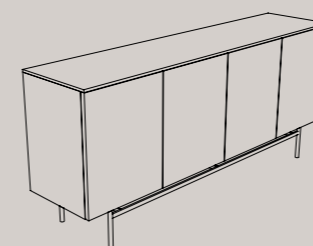

GLASS

Pag. 30

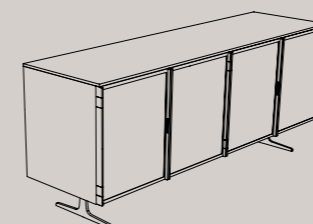

TRAY

Pag. 38

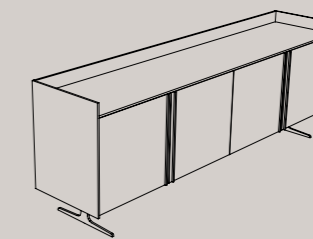

CLIO

Pag. 42

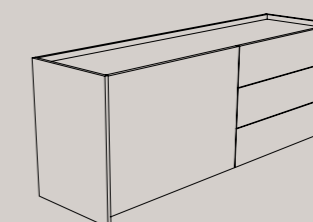

PUNTO 08

Pag. 46



SYSTEM MODULO

Un sistema estremamente versatile che attraverso le diverse declinazioni delle ante, accostamenti di finiture laccate o legno, permette infinite combinazioni. Un prodotto che cambia la sua personalità grazie ai diversi basamenti di design.

An extremely versatile system that allows infinite combinations through the different declinations of the doors, combinations of lacquered or wood finishes. A product that changes its personality thanks to the different design bases.

Finiture

Struttura laccato opaco Terra, anta Rombo laccato opaco Terra, ante Glass con vetro Trasparente e telaio Brunito.
Basamento Kako finitura brunito.

Finishes

Structure in Terra matt lacquered, Terra matt lacquered Rombo door, Glass door with Trasparente glass and Brunito frame.
Kako base Brunito finish.

Dimensione - Dimensions

L 1800 x H 768 x P 500 mm





Finiture
Struttura frassino Cotto, top marmo Carrara Venatino.
Basamento Tiglio finitura Brunito.

Finishes
Structure in Frassino Cotto, Carrara Venatino marble top.
Tiglio base Brunito finish.

Dimensione - Dimensions
L 1800 x H 684 x P 500 mm

Codice - Code
L1F51138



Finiture
Struttura laccato opaco Argilla, vano a giorno frassino Cuoio, anta
Glass con vetro Trasparente e telaio Brunito.
Basamento Tiglio finitura Brunito.
Finishes
Structure in Argilla matt lacquered, frassino Cuoio open unit, Glass
door with Trasparente glass and Brunito frame.
Tiglio base Brunito finish.

Dimensione - Dimensions
L 1500 x H 868 x P 420 mm



MADIE - SIDEBOARDS

SYSTEM MODULO - 04



Finiture
Struttura e top frassino Ossidato.
Basamento Tiglio finitura brunito.
Finishes
Structure and top in Frassino Ossidato.
Tiglio base Brunito finish.

Dimensione - Dimensions
L 2100 x H 500 x P 420 mm

Codice - Code
L1F41180



Fondini e sponde interne dei cestoni e cassetti sono rivestite in ecopelle. Una finitura che si abbina con stile a tutte le facciate.



The internal sides and bottoms of the baskets and drawers are covered in faux-leather. A finish that combines all the front with style.

SYSTEM MODULO

Un sistema estremamente versatile che attraverso le diverse declinazioni delle ante, accostamenti di finiture laccate o legno, permette infinite combinazioni. Un prodotto che cambia la sua personalità grazie ai diversi basamenti di design.

An extremely versatile system that allows infinite combinations through the different declinations of the doors, combinations of lacquered or wood finishes. A product that changes its personality thanks to the different design bases.

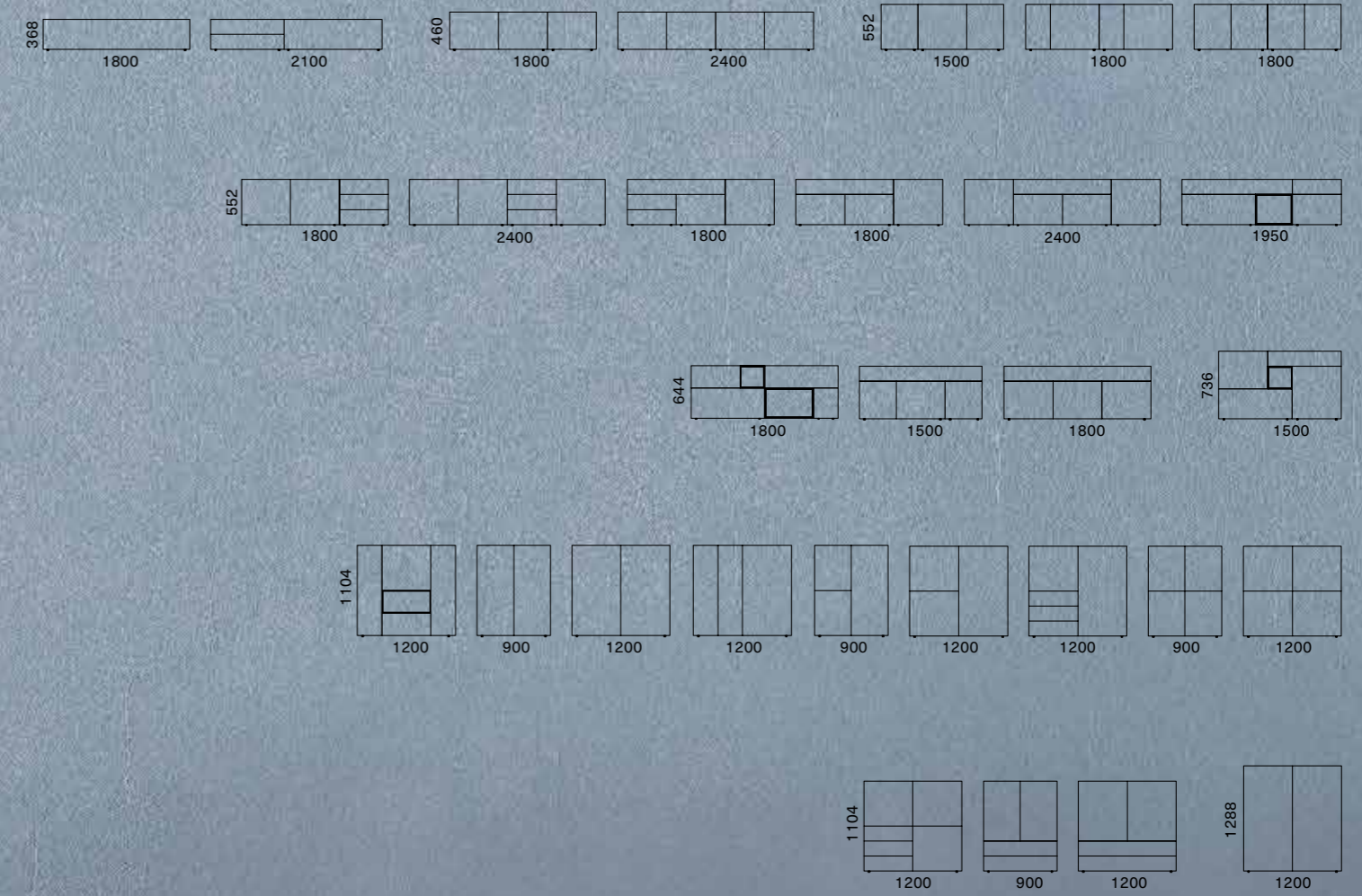

VIRGO

Una madia che si distingue per il forte carattere dell'anta, segnata da un inserto che funge da maniglia. Con la palette laccato opaco in contrasto con la facciata, crea una linea di colore che personalizza la tua casa.

A sideboard distinguished by the strong character of the door, marked by an insert that acts as a handle. With the matt lacquered palette in contrast with the fronts, it creates a colour line that personalises your home.



Finiture
Struttura laccato opaco Caramello, anta Virgo e maniglia laccato opaco caramello, cassetti frassino Cuoio.
Basamento Tiglio finitura Brunito.

Finishes
Structure in Caramello matt lacquered, Virgo door and Caramello matt lacquered handle, frassino Cuoio drawers.
Tiglio base Brunito finish.

Dimensione - Dimensions
L 2400 x H 776 x P 500 mm

Codice - Code
L1F51258



**Finiture**

Struttura frassino Carbone, anta Virgo frassino Carbone con maniglia laccato opaco Tufo.

Basamento Tiglio finitura Brunito.

Finishes

Structure in frassino Carbone, Virgo frassino Carbone door with Tufo matt lacquered handle.

Tiglio base Brunito finish.

Dimensione - Dimensions

L 1200 x H 1408 x P 420 mm

Codice - Code

L1F43204

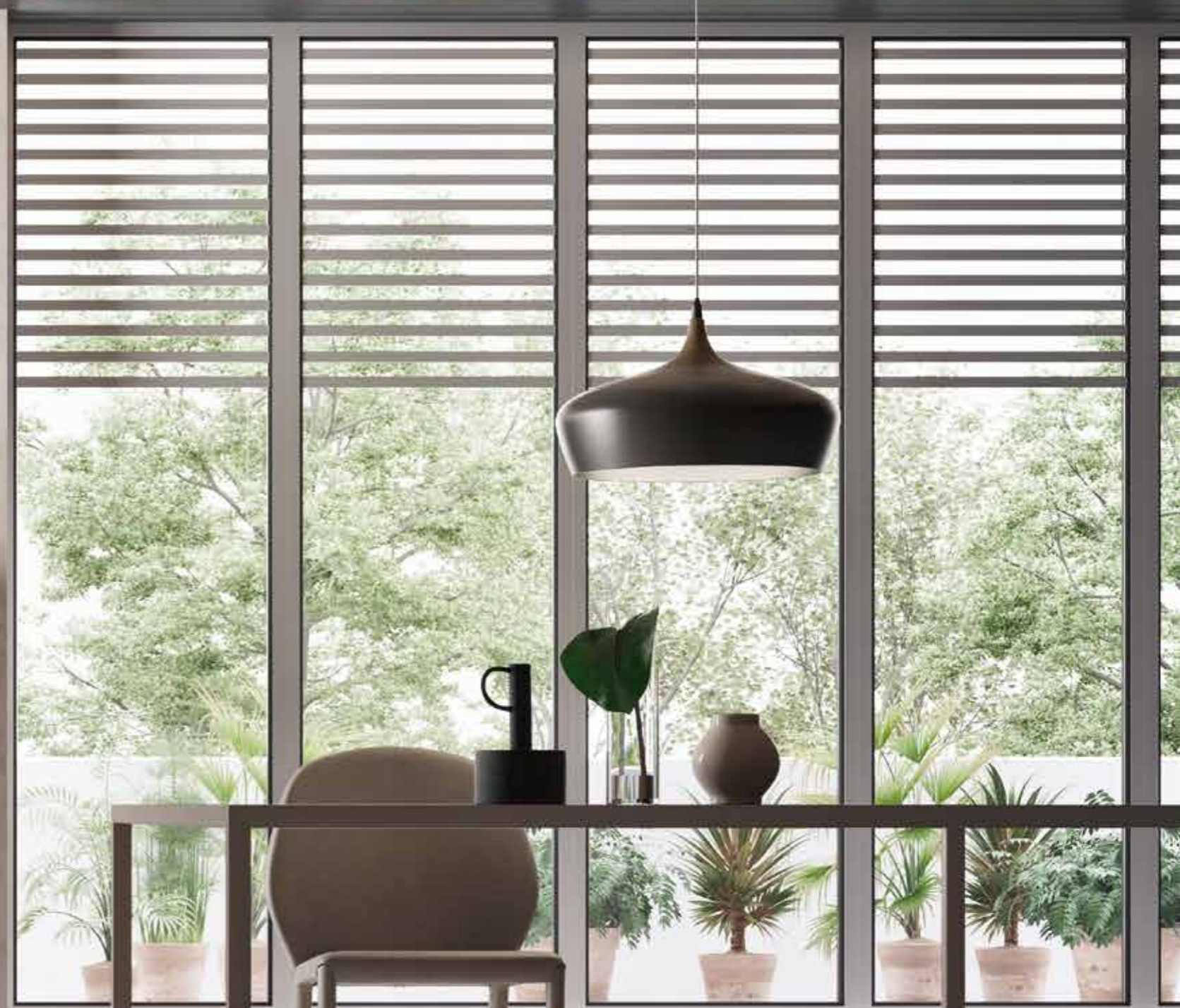



L'inserto laccato opaco Tufo dell'anta Virgo, insieme ai ripiani in vetro Bronzato e ai cassetti in cuoio Brown arricchiscono con eleganza la madia.

The Tufo matte lacquered insert of the Virgo door, together with the Bronzato glass shelves and the Brown leather drawers, elegantly enrich the sideboard.

VIRGO

Una madia che si distingue per il forte carattere dell'anta, segnata da un inserto che funge da maniglia. Con la palette laccato opaco in contrasto con la facciata, crea una linea di colore che personalizza la tua casa.

A sideboard distinguished by the strong character of the door, marked by an insert that acts as a handle. With the matt lacquered palette in contrast with the fronts, it creates a colour line that personalises your home.

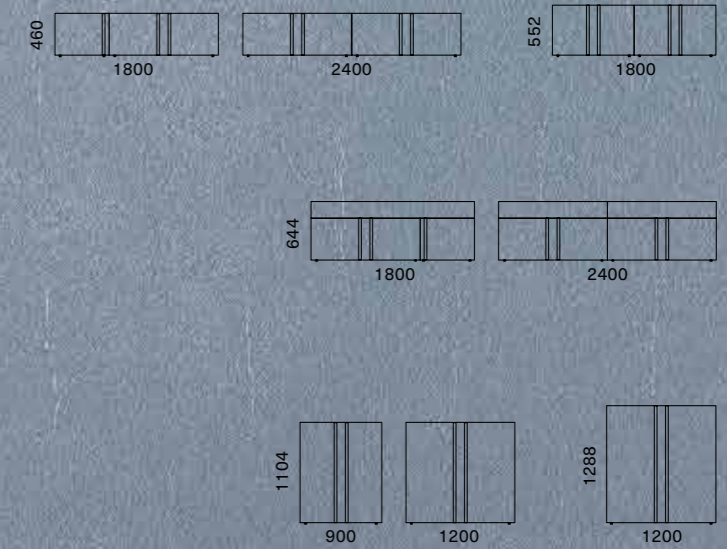

ROMBO

Un disegno ricercato, che crea una texture dall'effetto trapuntato. Combinata con il giusto basamento e nelle varianti laccato opaco offre un prodotto d'arredo per un'ambiente raffinato e contemporaneo.

A refined design that creates a quilted effect texture. Combined with the right base and in the matt lacquered variants, it offers a furnishing product for a refined and contemporary environment.

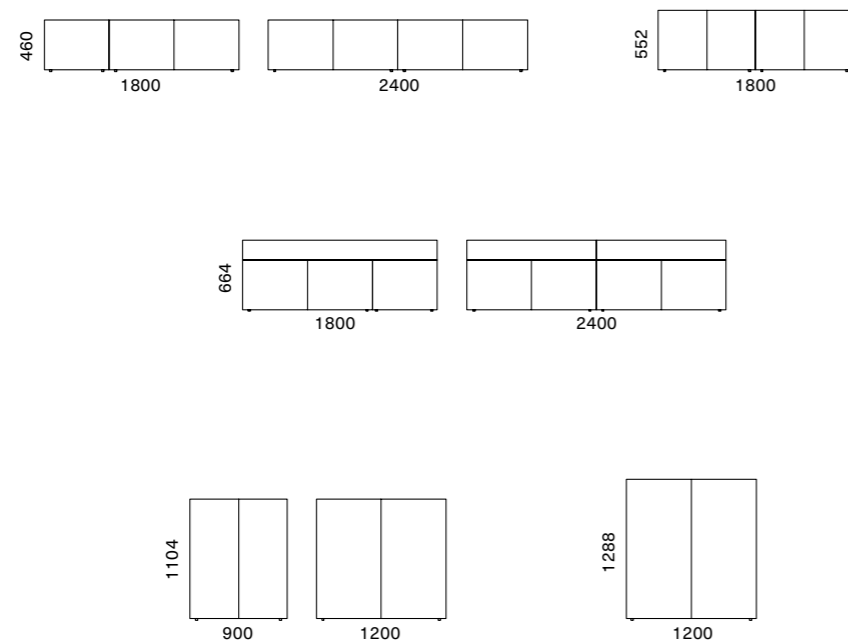

Finiture
Struttura laccato opaco Nebbia, anta Rombo laccato opaco Nebbia.

Finishes
Structure in Nebbia matt lacquered, Nebbia matt lacquered Rombo door.

Dimensione - Dimensions
L 1200 x H 1124 x P 500 mm

Codice - Code
L1F53252



MADIE - SIDEBOARDS

Finiture

Struttura laccato opaco Prugna, anta Rombo laccato opaco Prugna.
Basamento Dalia finitura Brunito.

Finishes

Structure in Prugna matt lacquered, Prugna matt lacquered Rombo door.
Dalia base Brunito finish.

Dimensione - Dimensions

L 1800 x H 768 x P 420 mm

Codice - Code

L1F41302



ROMBO - 02



GLASS

Un profilo vetrina attuale corredato da vetri in più finiture, si abbina ad ante materiche, laccate e resina. Con forti emozioni di luce che si riflettono su ripiani interni bronzati, permette di lavorare con fantasia progettuale.

A current showcase profile with glasses in several finishes, is combined with material, lacquered and resin doors. With strong emotions of light reflected on bronzed interior shelves, it allows you to work with design imagination.



Finiture
Struttura laccato opaco Cannella, anta Glass con pannello frassino
Ossidato e telaio Brunito.
Basamento Dalia finitura Brunito.
Finishes
Structure in Cannella matt lacquered, Glass door with frassino
Oxidized panel and Brunito frame.
Dalia base Brunito finish.

Dimensione - Dimensions
L 2400 x H 756 x P 500 mm



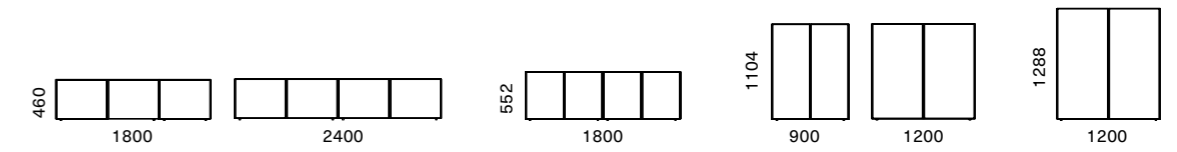

Finiture

Struttura laccato opaco Terra, anta Glass con pannello cemento Siena e vetro Bronzato, telaio Brunito.
Basamento Kako finitura Brunito.

Finishes

Structure in Terra matt lacquered, Glass door with cement Siena panel and Bronzato glass, Brunito frame.
Kako base Brunito finish.

Dimensione - Dimensions

L 1800 x H 768 x P 500 mm



Finiture
Struttura frassino Cotto, anta Glass con vetro Serigrafato Tessuto e telaio Brunito.
Basamento Dalia finitura Brunito.
Finishes
Structure in Frassino Cotto, Glass door with Serigrafato Tessuto glass and Brunito frame.
Dalia base Brunito finish.

Dimensione - Dimensions
L 1200 x H 1408 x P 420 mm

Codice - Code
L1F43312



Una madia impreziosita dall'anta Glass dal vetro Serigrafato tessuto. I LED incassati nei fianchi sottolineano i ripiani in vetro Bronzato e i cassetti in cuoio danno un tocco ricercato.

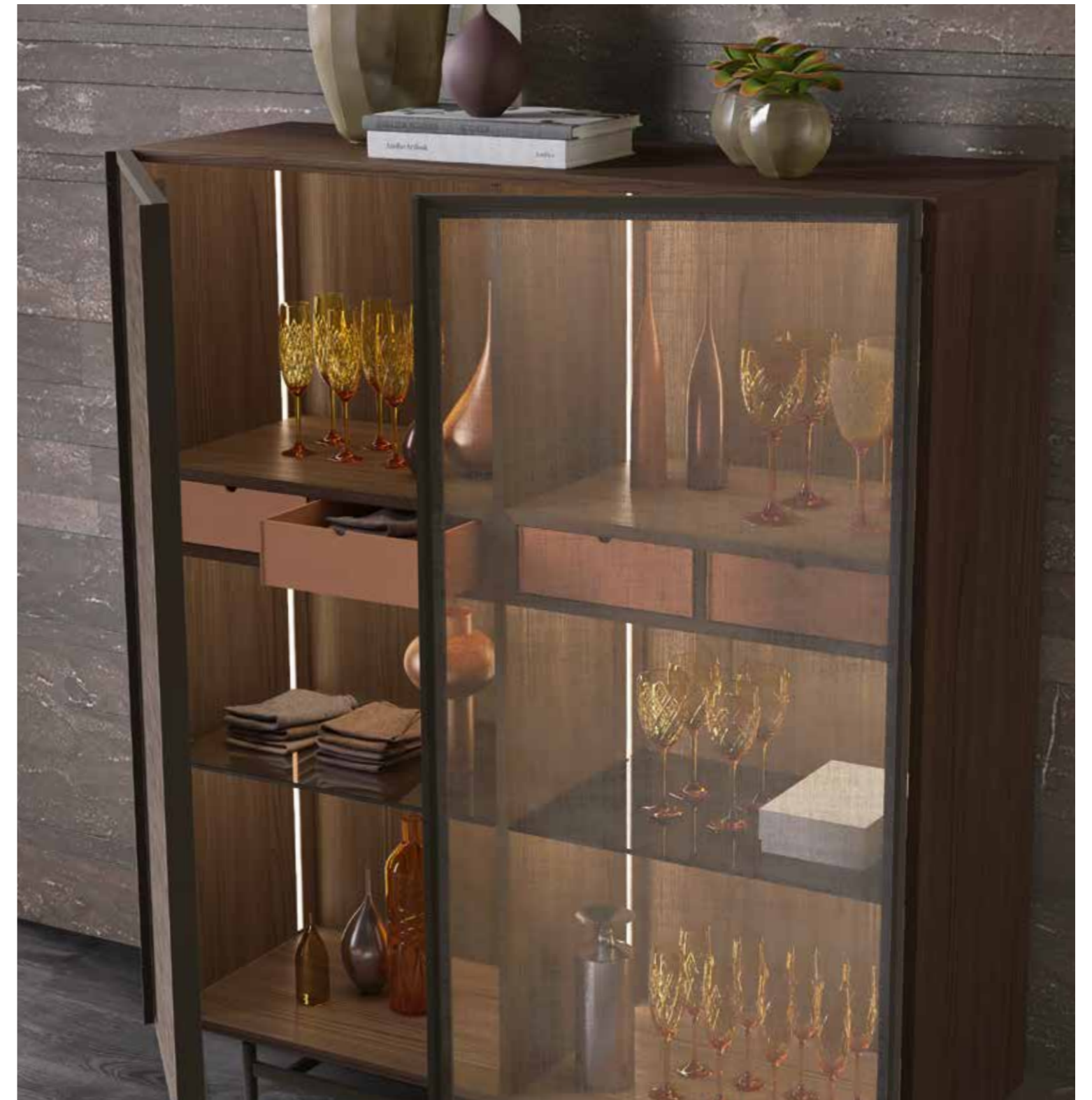

A sideboard embellished by the Glass door from the Serigrafato tessuto fabric glass. The LEDs embedded in the sides underline the Bronzato glass shelves and the leather drawers to give a refined touch.

TRAY

Un'originale scocca che abbraccia la madia e crea una sorta di vassoio. Dalla tradizione del design Italiano deriva un prezioso mood, dove proporzione e dettaglio fanno da padroni.

An original body that embraces the sideboard and creates a sort of tray. From the Italian design tradition comes a precious mood, where proportion and detail are the masters.

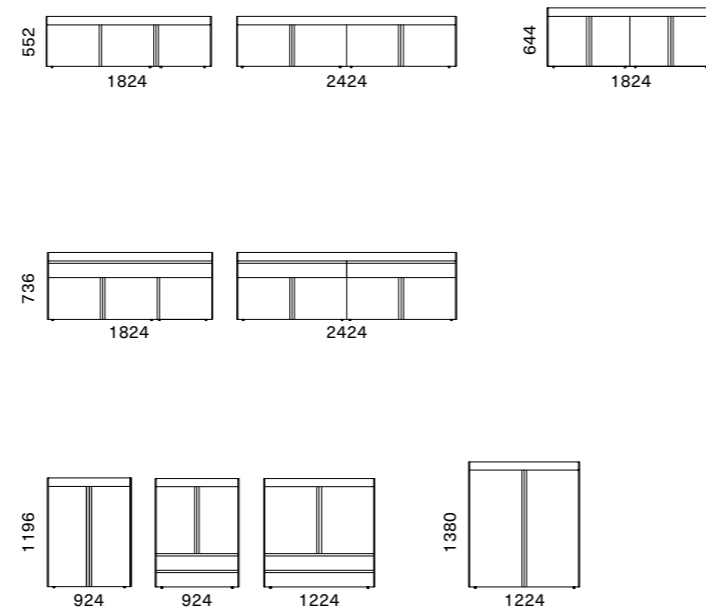

Finiture
Struttura laccato opaco Argilla, fianchi e vassoio frassino Carbone, maniglia Tratto finitura laccato opaco Tufo.

Finishes
Structure in Argilla matt lacquered, frassino Carbone sides and tray, Tufo matt lacquered finish Tratto handle.

Dimensione - Dimensions
L 924 x H 1196 x P 500 mm

Codice - Code
L1F53352



Finiture

Struttura laccato opaco Nebbia, fianchi e vassoio frassino Ossidato, maniglia Tratto finitura laccato opaco Tufo. Basamento Kako finitura Brunito.

Finishes

Structure in Nebbia matt lacquered, frassino Ossidato sides and tray, Tufo matt lacquered finish Tratto handle. Kako base Brunito finish.

Dimensione - Dimensions

L 1824 x H 756 x P 500 mm

Codice - Code

L1F51402

CLIO

Una soluzione con apertura complanare. Il massimo della pulizia formale si tramuta con originalità nel momento in cui indossa i colori audaci presi dall'ampia palette che corredda tutta la produzione.

A solution with coplanar opening. The maximum of formal cleanliness turns into originality when wearing the bold colours taken from the wide palette that accompanies the entire production.

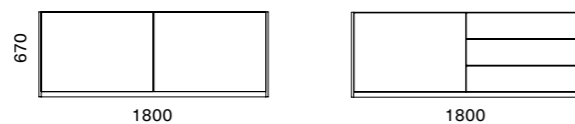

Finiture
Struttura e fianchi laccato opaco Cannella, top marmo Carrara Venatino.
Finishes
Structure and top in Cannella matt lacquered, Carrara Venatino marble top.

Dimensione - Dimensions
L 1800 x H 670 x P 523 mm

Codice - Code
L1F54104



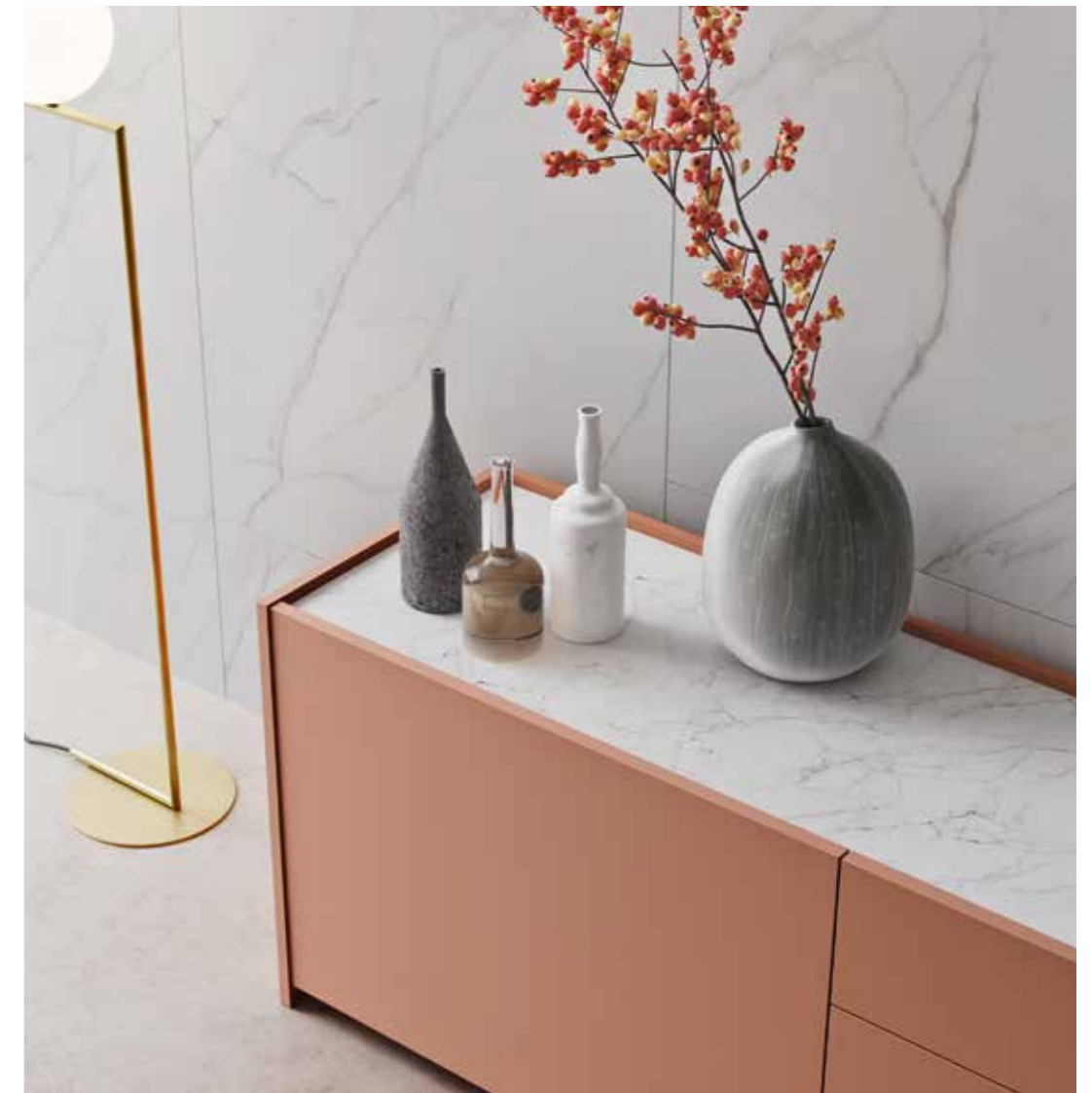

Dettagli come il top in marmo Carrara Venatino e le luci LED interne che illuminano i ripiani in vetro bronzato, arricchiscono e danno valore aggiunto.

Details such as the Carrara Venatino marble top and interior LED lights that illuminate the Bronzoto glass shelves, enrich and add value.

PUNTO 08

Un segno distintivo caratterizza il fianco formando inediti abbinamenti e permette di spaziare con la fantasia. Questa peculiarità insieme alla maniglia dal design semplice ed essenziale fanno della Punto08 una madia unica e gradevole.

A distinctive mark characterises the side forming unprecedented combinations and allows you to wander with fantasy. This peculiarity together with the handle with simple and essential design make the Punto08 a unique and pleasant sideboard.



Finiture

Struttura e fianchi laccato opaco Sahara, cassetti con fianchi e top frassino Cotto, maniglia Linea finitura laccato opaco Tufo. Basamento Kako finitura Brunito.

Finishes

Structure and sides in Sahara matt lacquered, drawers with frassino Cotto sides and top, Tufo matt lacquered finish Linea handle. Kako base Brunito finish.

Dimensione - Dimensions
L 1816 x H 948 x P 500 mm

Codice - Code
L1F51506



Finiture

Struttura e fianchi frassino Cuoio, cassetti con fianchi e top laccato opaco Nebbia, maniglia Linea finitura laccato opaco Tufo.
Basamento Erica finitura Brunito.

Finishes

Structure and sides in Frassino Cuoio matt lacquered, drawers with Nebbia matt lacquered sides and top, Tufo matt lacquered finish Linea handle.
Erica base Brunito finish.

Dimensione - Dimensions

L 2416 x H 680 x P 420 mm

Codice - Code

L1F41508

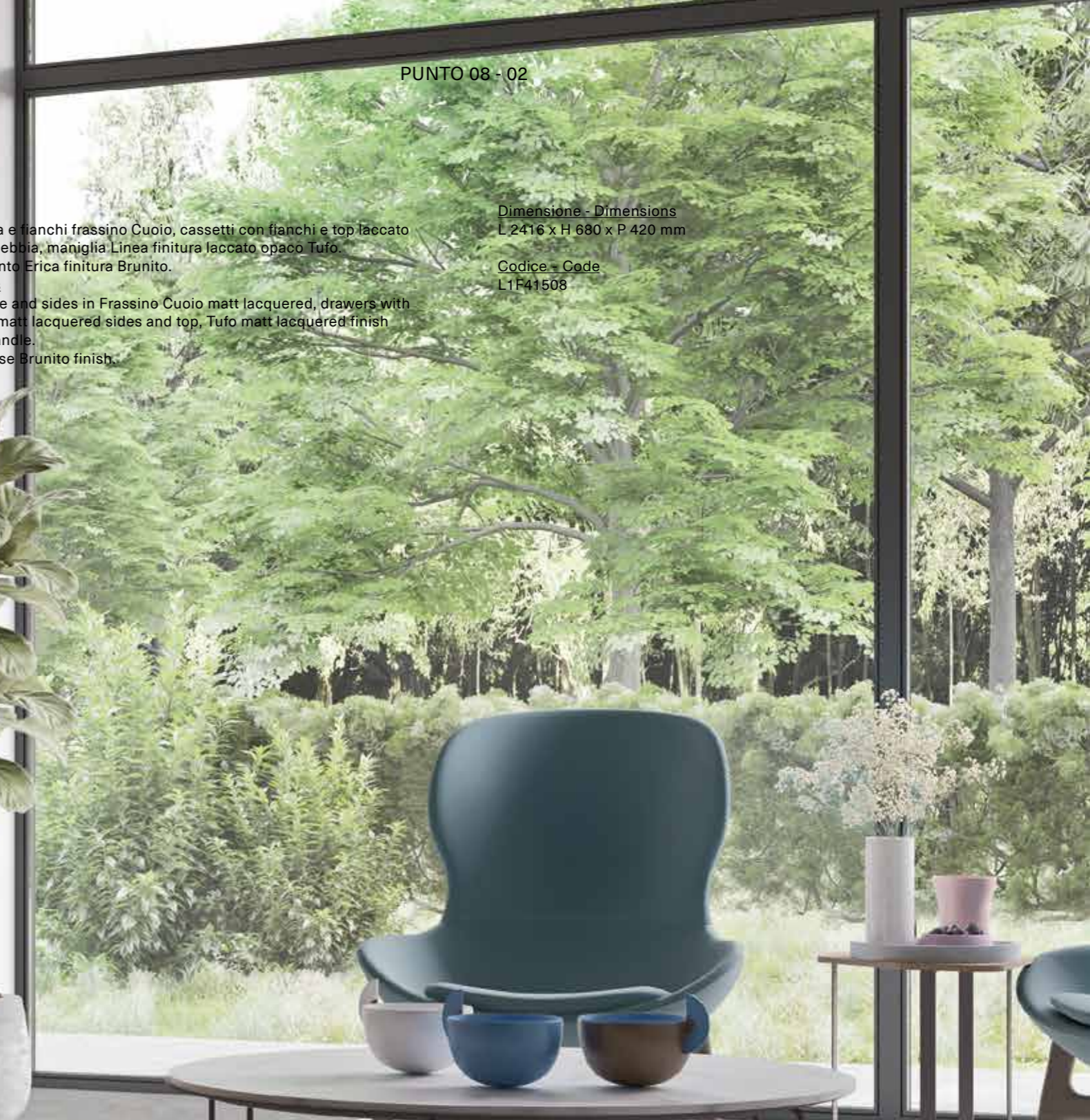



Dettagli importanti con abbinamenti inusuali. L'accostamento di fianchi e top personalizzabili con diverse finiture sono la particolarità della madia Punto 08.



Important details with unusual combinations. The particularity of the Punto 08 sideboard are the combination of sides and tops that can be customised with different finishes.

PUNTO 08

Un segno distintivo caratterizza il fianco formando inediti abbinamenti e permette di spaziare con la fantasia. Questa peculiarità insieme alla maniglia dal design semplice ed essenziale fanno della Punto08 una madia unica e gradevole.

A distinctive mark characterises the side forming unprecedented combinations and allows you to wander with fantasy. This peculiarity together with the handle with simple and essential design make the Punto08 a unique and pleasant sideboard.

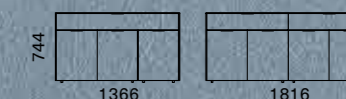
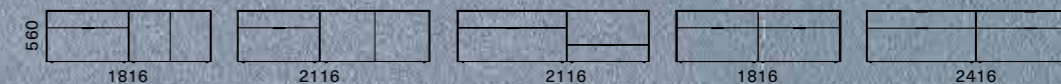
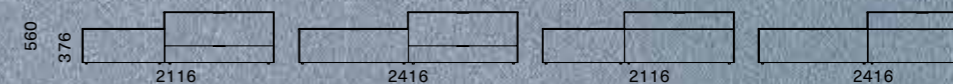

LIBRERIE BOOKCASES

Spaziare nel progetto tra il minimalismo sintetico di Wall 12 ed il programma Grafic lascia libero accesso alla fantasia. Disegnando gradevoli soluzioni e giocando negli abbinamenti con le molteplici finiture, si ottengono risultati progettuali utili a tutte le necessità.

Spacing in the design between the synthetic minimalism of Wall 12 and the Grafic program leaves free access to the imagination. By designing pleasing solutions and playing in combinations with the many finishes, you get project results that are useful for all your needs.

WALL 12

Pag. 56

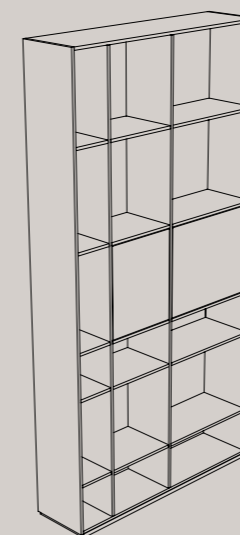

GRAFIC

Pag. 58

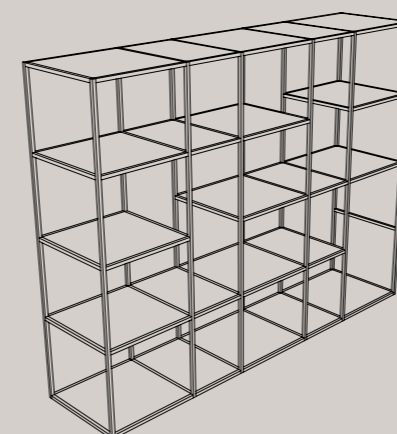

WALL 12

Lo spessore 12 mm è l'elemento costruttivo che distingue questa libreria. In poco spazio con vani di svariate misure e con ante che racchiudono gli elementi più preziosi, è perfetta per l'esposizione degli oggetti più cari raccolti nell'arco di una vita.

The 12 mm thickness is the constructive element that distinguishes this bookcase. In little space with compartments of various sizes and with doors that contain the most precious elements, it is perfect to display the most expensive objects collected over a lifetime.

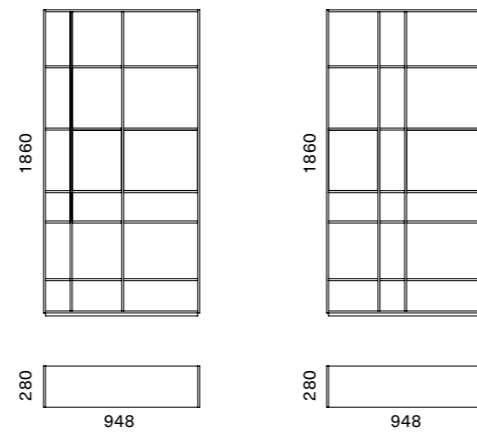

Finiture
Struttura laccato opaco Ortensia, anta frassino Cuoio.
Finishes
Structure in Argilla matt lacquered, frassino Cuoio door.

Dimensione - Dimensions
L 948 x H 1860 x P 280 mm

Codice - Code
A - L1K04600
L1K04642 - L1K04640
B - L1K04602
L1K04642 - L1K04640



GRAFIC

Programma libreria con struttura in metallo 15x15 mm. A un telaio laccato opaco è possibile abbinare schiene e ripiani di diverse finiture. La sua libertà compositiva e l'ampia palette di colori, garantiscono un progetto utile per arredare e soddisfare svariate esigenze di utilizzo.

Bookcase design with 15x15 mm metal frame. A matt lacquered frame can be combined with backs and shelves of different finishes. Its compositional freedom and wide palette of colours guarantee a useful design to furnish and satisfy various needs of use.



Finiture
Telaio laccato opaco Tufo, ripiani frassino Ossidato.
Finishes
Tufo matt lacquered frame, frassino Ossidato shelves.

Dimensione - Dimensions
L 2415 x H 771 x P 456 mm



Finiture

Telaio laccato opaco Cannella, ripiani frassino Ossidato e laccato opaco Cannella.

Finishes

Cannella matt lacquered frame, frassino Ossidato shelves and Cannella matt lacquered.

Dimensione - Dimensions

L 1965 x H 1507 x P 456 mm





Finiture
Telaio laccato opaco Titanio, ripiani frassino Carbone e laccato opaco Prugna.
Finishes
Titanio matt lacquered frame, frassino Carbone shelves and Prugna matt lacquered.

Dimensione - Dimensions
L 4215 x H 1139 x P 328 mm



Finiture
 Telaio laccato opaco Tufo, ripiani e schiene frassino Cotto.
 Finishes
 Tufo matt lacquered frame, frassino Cotto shelves and back.

Dimensione - Dimensions
 L 2865 x H 1507 x P 456 mm

GRAFIC

Programma libreria con struttura in metallo 15x15 mm. A un telaio laccato opaco è possibile abbinare schiene e ripiani di diverse finiture. La sua libertà compositiva e l'ampia palette di colori, garantiscono un progetto utile per arredare e soddisfare svariate esigenze di utilizzo.

Bookcase design with 15x15 mm metal frame. A matt lacquered frame can be combined with backs and shelves of different finishes. Its compositional freedom and wide palette of colours guarantee a useful design to furnish and satisfy various needs of use.

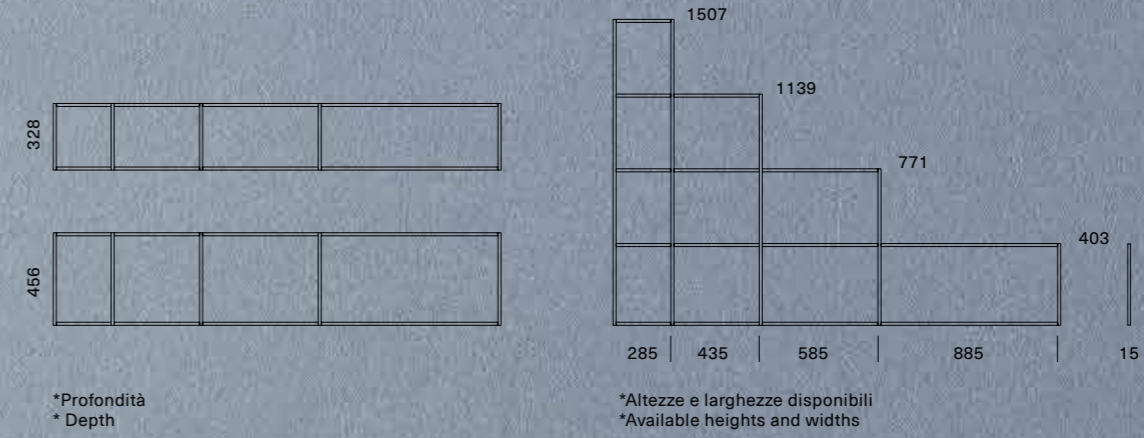

TAVOLI TABLES

Tavoli allungabili e tavoli fissi, versatili perché si possono adattare a momenti di vita diversi, dallo studio, al relax alla convivialità.

Funzionali poiché coniugano design ed estetica. Trasversali perché si vestono in tanti modi mantenendo sempre l'unicità che li contraddistingue.

Extendible tables and fixed tables, versatile because they can be adapted to different moments of life, from study, to relaxation and conviviality. Functional as they combine design and aesthetics. Transversal because they are dressed in many ways always maintaining the uniqueness that distinguishes them.

SAMBUCO

Pag. 70

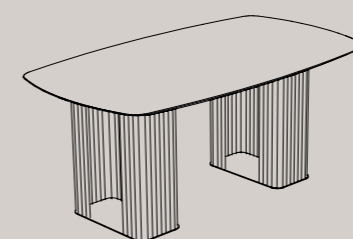

PINO

Pag. 74

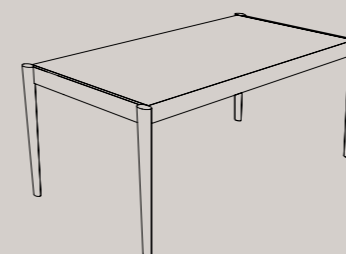

SLIM

Pag. 78

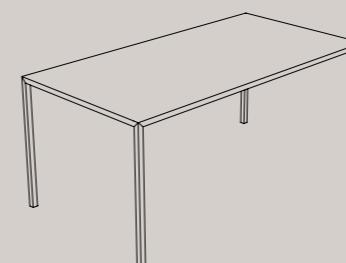

LUIS

Pag. 82



SAMBUCO

Un tavolo dalla struttura metallica leggera ed aerea, corredato da numerosi piani dalle svariate misure e finiture, con profili diversi adattabili ai gusti più disparati. Un oggetto di design che nel contempo diventa prezioso ed utile nel vivere quotidiano.

A table with a light and airy metal structure, complete with numerous tops with different sizes and finishes, with different profiles adaptable to the most diverse tastes. A design object that at the same time becomes valuable and useful in everyday life.

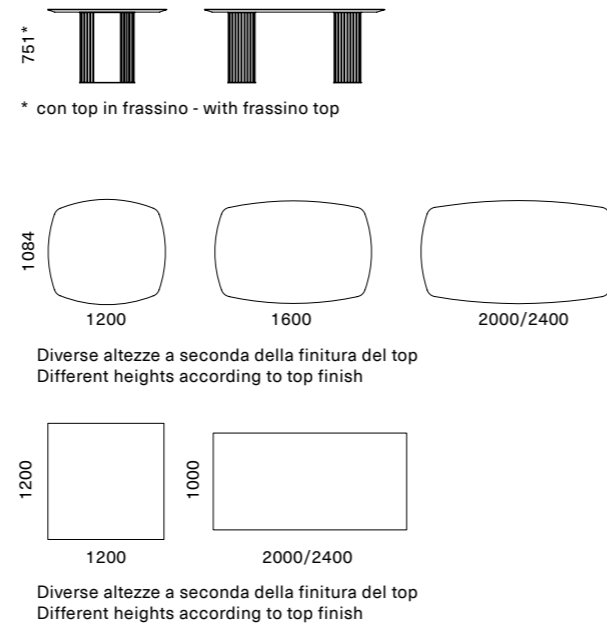

Finiture
Basamento finitura Brunito, MDF laccato opaco Tufo e top ellittico in marmo Grigio Oriente.

Finishes
Brunito finish base, Tufo matt lacquered MDF and Grigio Oriente marble elliptic top.

Dimensione - Dimensions
L 1200 x 1084 x H 759 mm

Codice - Code
L1S01302



Finiture

Basamento finitura Brunito, MDF laccato opaco Tufo e top ellittico in frassino Carbone.

Finishes

Brunito finish base, Tufo matt lacquered MDF and frassino Carbone elliptic top.

Dimensione - Dimensions

L 2400 x 1066 x H 751 mm

Codice - Code

L1S01331



PINO

Un tavolo dal design ricercato che si fa notare per la particolarità delle gambe che emergono dal piano. Presente anche nella versione allungabile, è pensato nelle calde essenze del legno.

A table with a refined design that stands out for the particularity of the legs that emerge from the top. Also available in the extendible version, it is designed in the warm wood essences.

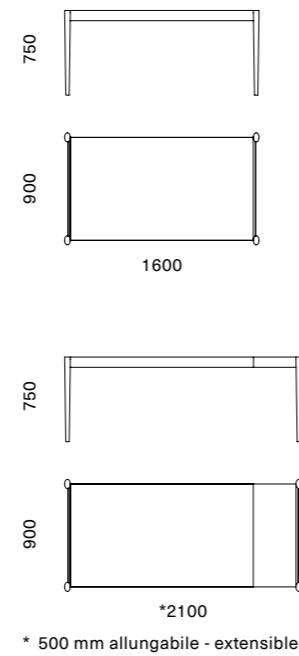

Finiture
Frassino Cotto.
Finishes
Frassino Cotto.

Dimensione - Dimensions
L 1600 x 900 x H 750 mm + 500 mm

Codice - Code
L1S01450





Finiture
Frassino Ossidato.
Finishes
Frassino Ossidato.

Dimensione - Dimensions
L 1600 x 900 x H 750 mm

Codice - Code
L1S01450

SLIM

Una struttura metallica leggera permette a questo tavolo, sia quadrato che rettangolare, di essere posizionato in più ambienti della casa o dell'ufficio.

Nelle numerose finiture laccato opaco Slim assume un carattere essenziale, ma nella versione con il piano in marmo si impreziosisce.

A light metal structure allows this table, both square and rectangular, to be placed in various rooms from the home to office.

In the numerous matt lacquered finishes, Slim assumes an essential character, but in the version with the marble top it is embellished.

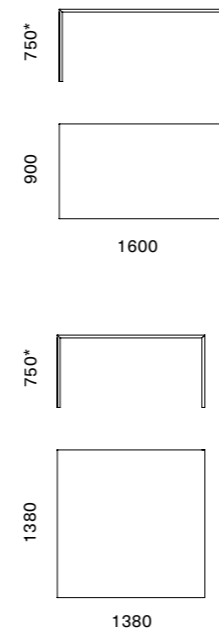

* con top laccato opaco - with matt lacquered top
Diverse altezze a seconda della finitura del top
Different heights according to top finish

Finiture
Basamento laccato opaco Tufo, top marmo Grigio Oriente.
Finishes
Tufo matt lacquered base, Grigio Oriente marble top.

Dimensione - Dimensions
L 1600 x 900 x H 770 mm

Codice - Code
L1S01431
L1S01438



Finiture
Da sinistra laccato opaco Nebbia, laccato opaco Artico.
Finishes
From the left, Nebbia matt lacquered, Artico matt lacquered

Dimensione - Dimensions
L 1380 x 1380 x H 750 mm

Codice - Code
L1S01430



LUIS

Il tavolo Luis nasce da un perfetto equilibrio tra solidità e leggerezza formale. Il suo aspetto cambia grazie alle svariate finiture in cui il piano, rettangolare o ellittico, è personalizzabile.

The Luis table comes from a perfect balance between solidity and formal lightness. Its appearance changes thanks to the various finishes in which the rectangular or elliptical top is customisable.

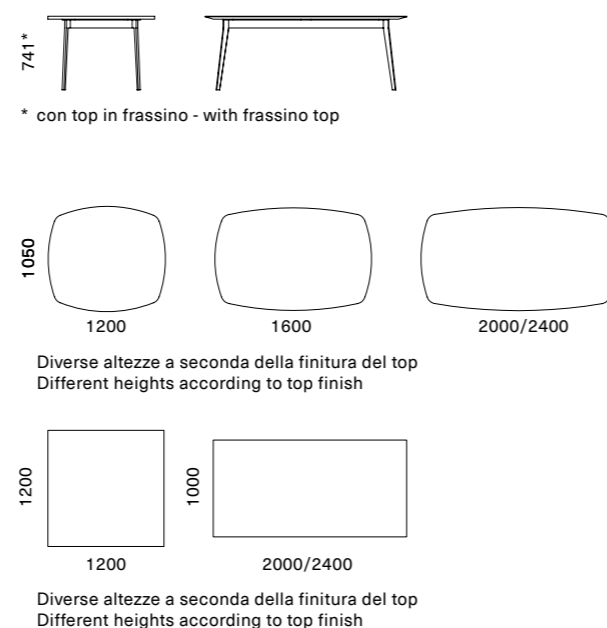

Finiture

Basamento finitura Brunito, MDF laccato opaco Tufo e top ellittico in marmo Carrara Venatino.

Finishes

Brunito finish base, Tufo matt lacquered MDF and Carrara Venatino marble elliptic top.

Dimensione - Dimensions

L 2400 x 1066 x H 759 mm

Codice - Code

L1S01402





Finiture
Basamento finitura Brunito, top frassino Ossidato.
Finishes
Brunito finish base, frassino Ossidato top.

Dimensione - Dimensions
L 2400 x 1000 x H 760 mm

Codice - Code
L1S01412

TAVOLINI

OCCASIONAL TABLES

I tavolini Orme rispondono a diverse esigenze di utilizzo e di stile. Tavolini da caffè, da salotto e relax. La varietà dei modelli proposti in diverse finiture, dal laccato opaco al più ricercato con piani in marmo, soddisfano i gusti più disparati in fatto di arredamento.

Orme occasional tables respond to different needs of use and style. Coffee tables, for living rooms and relax. The variety of models proposed in different finishes, from matt lacquer to the most refined with marble tops, satisfy the most diverse tastes in terms of furnishings.

SAMBUCO

Pag. 88

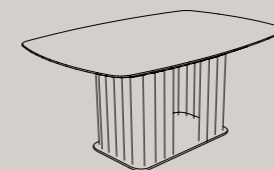

AMARANTO

Pag. 102

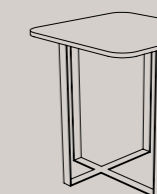

GINESTRA

Pag.92

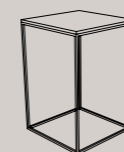

LAMA

Pag. 104

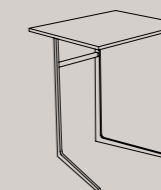

ASTER

Pag. 94

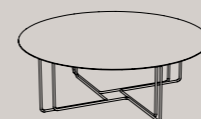

GLICINE

Pag. 108



FRUIT

Pag. 98

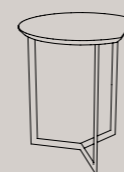

PUZZLE

Pag. 110

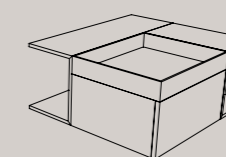

SAMBUCO

La collezione di tavolini Sambuco è caratterizzata da una struttura metallica ritmata da diversi tondini. Con le sue diverse altezze, forme di piani e finiture disponibili, permette di creare soluzioni sempre diverse che danno valore al living.

The Sambuco occasional table collection is characterised by a metallic structure with different rods. With its different available heights, top shapes and finishes, it allows you to always create different solutions that give value to living.

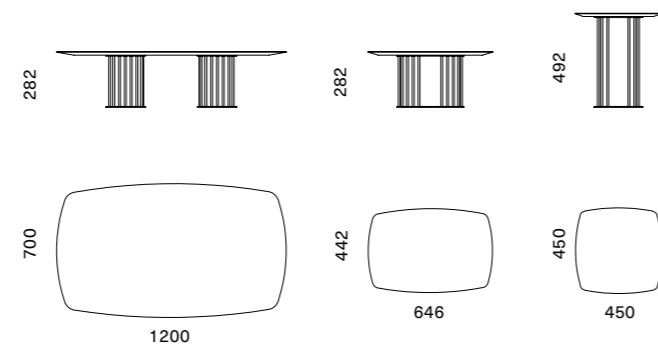

Finiture
Basamento finitura Brunito, top frassino Cotto e frassino Carbone.
Finishes
Brunito finish base, frassino Cotto and frassino Carbone top.

Dimensione - Dimensions
L 646 x 442 x H 282 mm
L 450 x 450 x H 492 mm

Codice - Code
L1S01071
L1S01061



TAVOLINI - OCCASIONAL TABLES

Finiture

Da sinistra basamento finitura Brunito, top marmo Grigio Oriente.
Basamento finitura Brunito, top frassino Ossidato.

Finishes

From the left, Brunito finish base, frassino Cotto top.
Brunito finish base, Carrara Venatino marble top.

Dimensione - Dimensions

L 1200 x 700 x H 282 mm
L 450 x 450 x H 500 mm

Codice - Code

L1S01081
L1S01062



SAMBUCO - 02



GINESTRA

Tavolino dalla struttura in metallo, si caratterizza per il suo aspetto filiforme e per la rigidità del piano. Presentato solo in due misure, si adatta a qualsiasi ambiente per la vasta scelta di top dalle molteplici finiture e palette colore.

Occasional table with metal structure, characterised by its streamline appearance and the rigourousness of the top. Available only in two sizes, it adapts to any environment due to the vast choice of tops with multiple finishes and colour palettes.

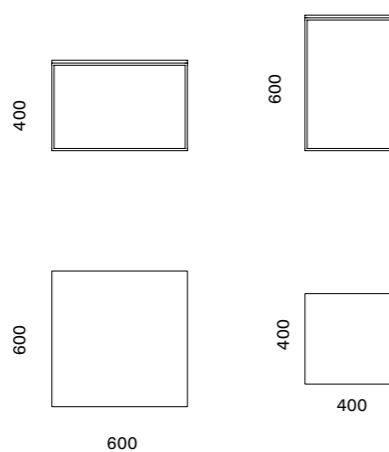

Finiture
Basamento finitura Brunito, top cemento Ghisa e cemento Pietra.
Finishes
Brunito finish base, cemento Ghisa and cement Pietra top.

Dimensione - Dimensions
L 600 x 600 x H 400 mm
L 400 x 400 x H 600 mm

Codice - Code
L1S01002
L1S01000



ASTER

Un incrocio di esili tondini formano un gradevole basamento dal leggero aspetto. Un prodotto eclettico dal profilo ricercato e con il piano personalizzabile nelle diverse finiture, dalle più naturali essenze del legno all'eleganza del marmo.

An intersection of slender rods form a pleasant base with a slight appearance. An eclectic product with a refined profile and a customisable surface in different finishes, from the most natural wood species to the elegance of marble.

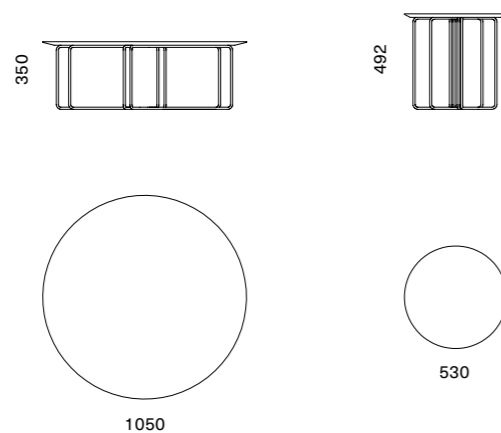

Finiture
Basamento finitura Brunito, piano marmo Grigio Oriente.
Finishes
Brunito finish base, Grigio Oriente marble top.

Dimensione - Dimensions
D 1050 x H 350 mm

Codice - Code
L1S01042





Finiture
 Da sinistra Basamento finitura Brunito, top frassino Cotto.
 Basamento finitura Brunito, top marmo Carrara Venatino.
Finishes
 From the left, Brunito finish base, frassino Cotto top.
 Brunito finish base, Carrara Venatino marble top.

Dimensione - Dimensions
 D 1050 x H 350 mm
 D 530 x H 492 mm

Codice - Code
 L1S01042
 L1S01031

FRUIT

Un tavolino essenziale che nasce dall'incrocio di lame e forme dal design contemporaneo. Il basamento disponibile anche nella vivace palette dei laccati, lascia una libertà infinita di combinazioni. Il piano dal taglio particolare, disponibile in diverse finiture, è ingentilito dal profilo rastremato.

An essential table that comes from the intersection of blades and shapes with a modern design. The base is also available in the lively lacquered palette, leaving an endless freedom of combinations. The particularly shaped surface, available in different finishes, is softened by the tapered profile.

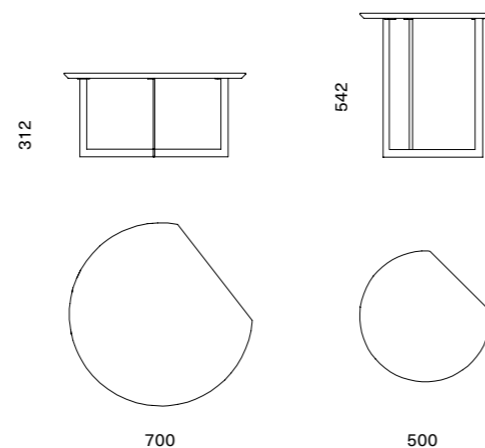

Finiture
 Basamento laccato opaco Ortensia, top frassino Ossidato.
 Basamento laccato opaco Tufo, top frassino Ossidato.
Finishes
 Ortensia matt lacquered base, frassino Ossidato top.
 Tufo matt lacquered base, frassino Ossidato top.

Dimensione - Dimensions
 D 700 x H 312 mm
 D 500 x H 542 mm

Codice - Code
 L1S01121
 L1S01120



SAMBUCO - GINESTRA - ASTER - FRUIT

I tavolini Orme lasciano ampia libertà di progettazione, e di creare infinite combinazioni grazie alle diverse dimensioni disponibili. Con i più svariati basamenti e piani sono una proposta originale per arredare e colorare i diversi spazi della casa.

Orme occasional tables leave plenty of design freedom, and create endless combinations thanks to the different sizes available. With the most varied bases and tops, they are an original proposal to furnish and colour the different spaces of the house.



AMARANTO

Per un pubblico dal gusto giovane e dinamico, Amaranto è un tavolino pensato per dare ritmo alla zona living. Il basamento semplice è arricchito da un piano, disponibile in diverse finiture, caratterizzato da angoli arrotondati e da una linea netta di taglio.

For an audience with a young and dynamic taste, Amaranto is a occasional table designed to give rhythm to the living area. The simple base is enriched by a top, available in different finishes, characterised by rounded corners and a sharp line.

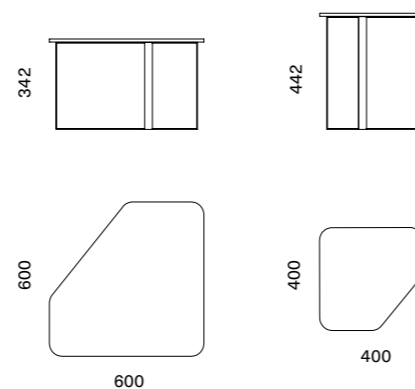

Finiture
Basamento finitura Brunito, top laccato opaco Fulvo e top frassino Carbone.
Finishes
Brunito finish base, Fulvo matt lacquered top and frassino Carbone top

Dimensione - Dimensions
L 600 x 600 x H 342 mm
L 400 x 400 x H 422 mm

Codice - Code
L1S01092
L1S01090



LAMA

Il basamento in metallo, che lavora come una lama, crea un sostegno solido e creativo per il piano. Lama, personalizzabile con diverse finiture, dispone anche di una conformazione pensata appositamente per dar servizio al divano o alle zone di lettura.

The metal base, which works like a blade, creates a solid and creative support for the top. Lama, customisable with different finishes, also has a shape designed specifically to give service to the sofa or reading areas.

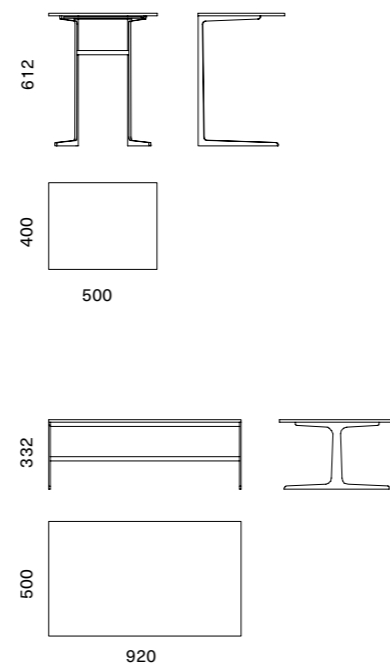

Finiture
Basamento finitura Brunito, top laccato opaco Indaco.
Finishes
Brunito finish base, Indaco matt lacquered top.

Dimensione - Dimensions
L 400 x 500 x H 612 mm

Codice - Code
L1S01050





Finiture
Da destra basamento finitura Brunito, top laccato opaco Indaco.
Basamento finitura Brunito, top frassino Ossidato.
Finishes
From the right Brunito finish base, Indaco matt lacquered top.
Brunito finish base, frassino Ossidato top.

Dimensione - Dimensions
L 920 x 500 x H 332 mm
L 400 x 500 x H 612 mm

Codice - Code
L1S01052
L1S01050

GLICINE

Glicine è un tavolino dal gusto contemporaneo, con un basamento in metallo che conferisce leggerezza al prodotto. Presentato in due misure ha un piano rastremato disponibile in diverse finiture.

Glicine is a occasional table with a contemporary taste, with a metal base that gives lightness to the product. Available in two sizes, it has a tapered top available in different finishes.

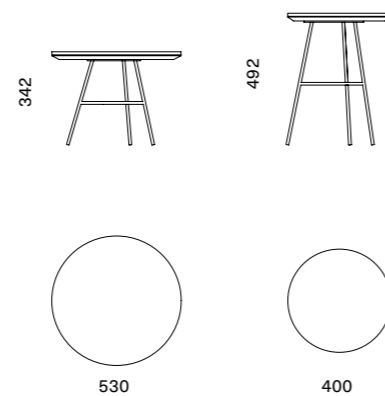

Finiture
Basamento finitura Brunito, top laccato opaco Argilla.
Basamento finitura Brunito, top laccato opaco Nebbia.
Finishes
Brunito finish base, Argilla matt lacquered top.
Brunito finish base, Nebbia matt lacquered top.

Dimensione - Dimensions
D 530 x H 349 mm
D 400 x H 499 mm

Codice - Code
L1S01020
L1S01010



PUZZLE

Con la sua duplice versione, con e senza vassoio, il tavolino si caratterizza per il gioco di volumi. Piano, vassoio e struttura, disponibili in diversi materiali e colori, creano un gioco cromatico che lo rendono accattivante per ogni ambiente.

With its dual version, with and without tray, the table is characterised by the play of volumes. Top, tray and structure, available in different materials and colours, create a chromatic play that make it attractive for every environment.

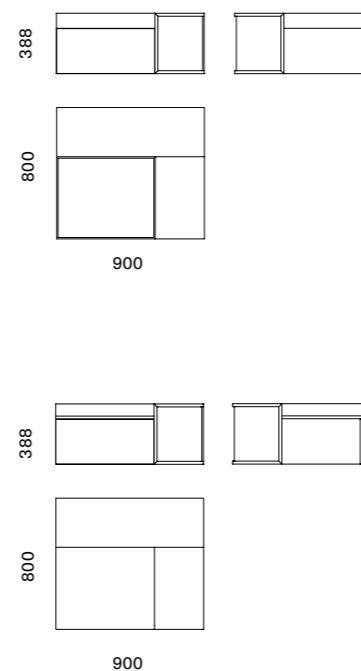

Finiture
Struttura frassino Cotto, top vassoio in marmo Grigio Oriente.
Finishes
Structure in frassino Cotto, Grigio Oriente marble tray top.

Dimensione - Dimensions
L 900 x 800 x H 388 mm

Codice - Code
L1S01102
L1S01105



Finiture
Struttura frassino Cotto, vassoio laccato opaco Fulvo.
Finishes
Frassino Cotto frame, Fulvo matt lacquered tray.

Dimensione - Dimensions
L 900 x 800 x H 388 mm
L1S01100



AMARANTO - LAMA - PUZZLE - GLICINE

I tavolini Orme lasciano ampia libertà di progettazione, e di creare infinite combinazioni grazie alle diverse dimensioni disponibili. Con i più svariati basamenti e piani sono una proposta originale per arredare e colorare i diversi spazi della casa.

Orme occasional tables leave plenty of design freedom, and create endless combinations thanks to the different sizes available. With the most varied bases and tops, they are an original proposal to furnish and colour the different spaces of the house.



SEDIE e POLTRONA

CHAIRS and ARMCHAIR

Sedute per ogni circostanza ed esigenza.
Ergonomiche e funzionali sono abbinabili perfettamente a tutti i tavoli, sia per forma che per le diverse finiture con cui possono essere rivestite: dai tessuti colorati e tramati, all'ecopelle dai colori naturali e al Nabuk.

Seating for every circumstance and requirement.
Ergonomic and functional they can be combined perfectly with all the tables, both for their shape and for the different finishes with which they can be covered: from coloured and textured fabrics, to faux-leather with natural colours to Nubuck.

TETRIS

Pag. 118



DAFNE

Pag. 122

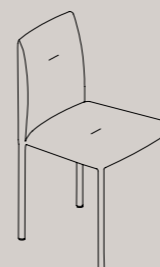

FANNY

Pag. 124



TOSCA

Pag. 128



DIAMANTE

Pag. 130

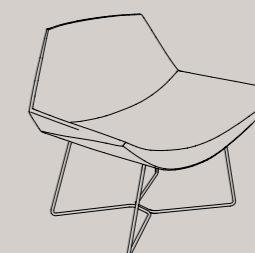

SEDIE - CHAIRS

TETRIS

La sua forma è avvolgente ed ergonomica, il suo stile ricercato e signorile. Le gambe, personalizzabili nelle diverse essenze del legno, si abbinano perfettamente ai diversi tessuti disponibili.

Its shape is enveloping and ergonomic, its style refined and elegant. The legs, which can be customised in the different woods, perfectly match the different fabrics available.



Finiture
Gamba frassino Carbone, ecopelle Nabuk N51.
Finishes
Frassino Carbone leg, faux-leather Nabuk N51.

Dimensione - Dimensions
L 510 x 580 x H 860 mm

Codice - Code
L1S01500



TETRIS

La sua forma è avvolgente ed ergonomica, il suo stile ricercato e signorile. Le gambe, personalizzabili nelle diverse essenze del legno, si abbinano perfettamente ai diversi tessuti disponibili.

Its shape is enveloping and ergonomic, its style refined and elegant. The legs, which can be customised in the different woods, perfectly match the different fabrics available.

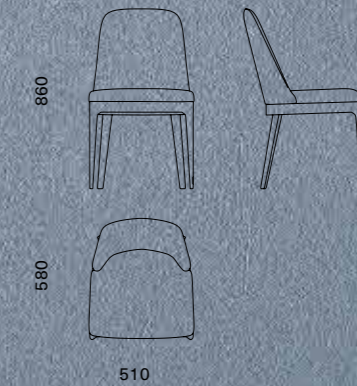

DAFNE

Una sedia da soggiorno con struttura in acciaio, un cuscino morbido applicato sulla seduta e sullo schienale. Rivestita completamente, comprese le gambe, con ecopelli personalizzate, rendono Dafne una sedia dallo stile inconfondibile ed originale. Riesce a posizionarsi e integrarsi in qualsiasi ambiente.

A chair with a steel frame, a soft cushion applied to the seat and back. Completely covered, including the legs, with custom faux leather, Dafne is a chair with an unmistakable and original style. It manages to position itself and integrate itself in any environment.

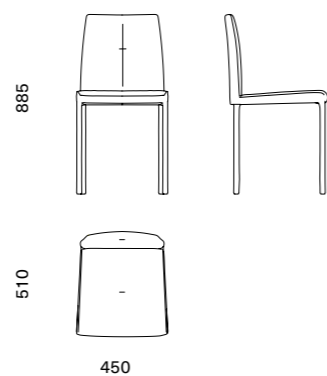

Finiture
Ecopelle Beige ed Ecopelle Vinaccia 10.
Finishes
Ecopelle Beige and Ecopelle Vinaccia 10.

Dimensione - Dimensions
L 450 x 510 x H 885 mm

Codice - Code
L1S01502



FANNY

Ad una seduta rigorosa, ma comoda ed ergonomica, si contrappone una scocca, presentata nelle diverse essenze del legno, che crea un profilo di design. Garantisce un'ampia possibilità utilizzo per i diversi spazi della casa.

A rigorous but comfortable and ergonomic seat contrasts with a body, available in the different woods, which creates a design profile. It guarantees a wide possibility of use for the different areas of the house.



Finiture
Gamba frassino Ossidato ed Ecopelle Vintage E71.
Finishes
Frassino Ossidato leg and Ecopelle Vintage E71.

Dimensione - Dimensions
L 435 x 525 x H 840 mm

Codice - Code
L1S01504



FANNY

Ad una seduta rigorosa, ma comoda ed ergonomica, si contrappone una scocca, presentata nelle diverse essenze del legno, che crea un profilo di design. Garantisce un'ampia possibilità utilizzo per i diversi spazi della casa.

A rigorous but comfortable and ergonomic seat contrasts with a body, available in the different woods, which creates a design profile. It guarantees a wide possibility of use for the different areas of the house.

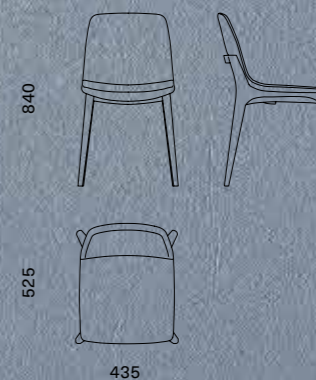

TOSCA

Pulizia formale e design ricercato per una sedia versatile ed ergonomica. Gambe, scocca e seduta sono completamente rivestite e personalizzabile con materiali come ecopelle e Nabuk.

Formal elegance and refined design for a versatile and ergonomic chair. Legs, body and seat are completely covered and customisable with materials such as faux leather and Nubuck.

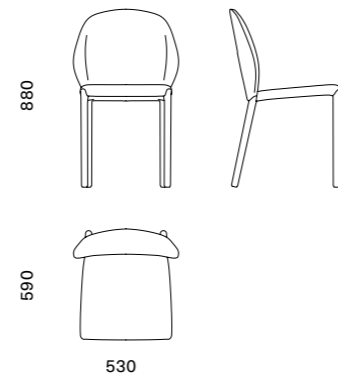

Finiture
Ecopelle Vintage E75 e ecopelle Nabuk N51.
Finishes
Ecopelle Vintage E75 and faux-leather Nabuk N51.

Dimensione - Dimensions
L 530 x 590 x H 880 mm

Codice - Code
L1S01506



DIAMANTE

Dalla forma contenuta, Diamante è una poltrona per zone di relax, attesa e conversazione. Con varie soluzioni di rivestimento e la soluzione bicolore, la rendono dinamica e spiritosa.

With its contained shape, Diamante is an armchair for areas of relaxation, waiting and conversation. The contemporary shaped base, various upholstery solutions and the two-colour solution make it dynamic and witty.

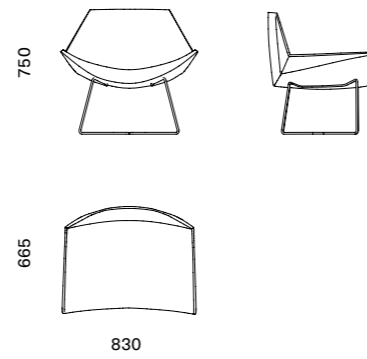

Finiture
Gamba finitura Brunito, seduta bicolore in tessuto Liberty L43 e L44.
Finishes
Brunito finish leg, two-tone Liberty L43 and L44 fabric seat.

Dimensione - Dimensions
L 830 x 665 x H 750 mm

Codice - Code
L1S01509



COMPLEMENTI e ACCESSORI

COMPLEMENTS and ACCESSORIES

Tanti i complementi pensati per completare l'arredo di una casa, necessari per dare un tocco di unicità, indispensabili per soddisfare esigenze progettuali. Versatili e personalizzabili nelle soluzioni estetiche, sono progettati con un pensiero analitico di un'azienda attenta a tutte le esigenze.

Many complements designed for home décor, necessary to give a touch of uniqueness, essential to meet design needs. Versatile and customisable in aesthetic solutions, they are designed with an analytical thought of a company attentive to all needs.

ALFRED

Pag. 134

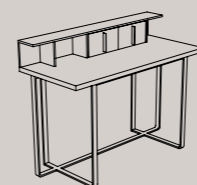

TEKA

Pag. 136

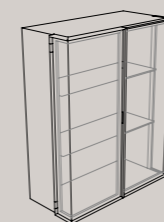

STREMA

Pag. 140

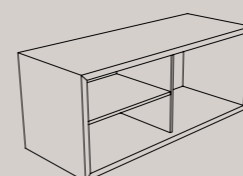

GRAFIC

Pag. 142

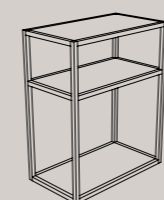

LANNY

Pag. 146

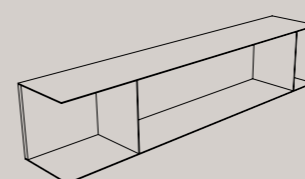

ACCORDO

Pag. 150

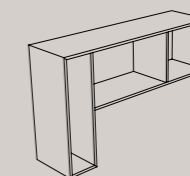

AIR

Pag. 152

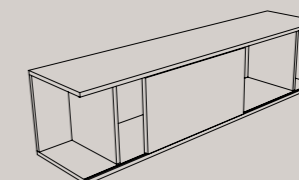

UNIT

Pag. 156

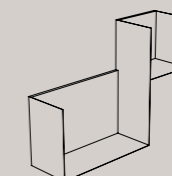

LULO

Pag. 160

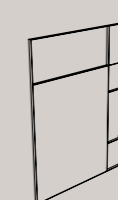

LIME

Pag. 162

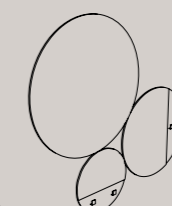

ALFRED

Elegante e pratico scrittoio dalla struttura metallica e piano corredato di alzata, impreziosito da divisori e cassetti in cuoio. Presentato con tre misure in larghezza, è adattabile a seconda delle necessità e ai diversi ambienti della casa.

Elegant and practical writing desk with a metal structure and a top with a riser, embellished with leather dividers and drawers. Available in three widths, it is adaptable according to the needs and the different rooms of the house.

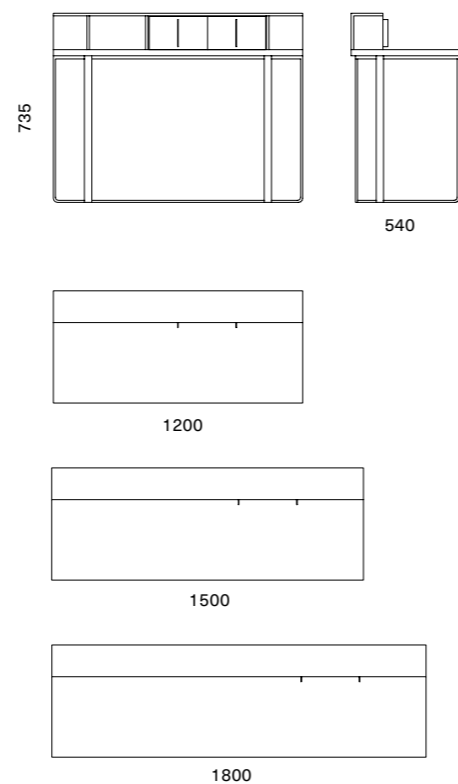

Finiture
Alzata laccato opaco Titanio, laccato opaco Tufo e cassetti in Cuoio Brown. Piano frassino Carbone.
Basamento finitura Brunito.

Finishes
Titanio matt lacquered riser, Tufo matt lacquered and Cuoio Brown drawers. Frassino Carbone top.
Brunito finish base.

Dimensione - Dimensions
L 1200 x H 735 x P 540 mm

Codice - Code
L1S01150



TEKA

Teka assume una personalità quasi museale, dove un profilo vetrina sagomato, vetri con diverse finiture, legni, materici e laccati ne determinano l'aspetto. Tutto ciò da un eccellente servizio per disporre gli oggetti più preziosi.

Teka takes on an almost museum personality, where a contoured showcase profile, glass with different finishes, woods, materials and lacquers determine its appearance. All this provides an excellent service to arrange the most precious objects.

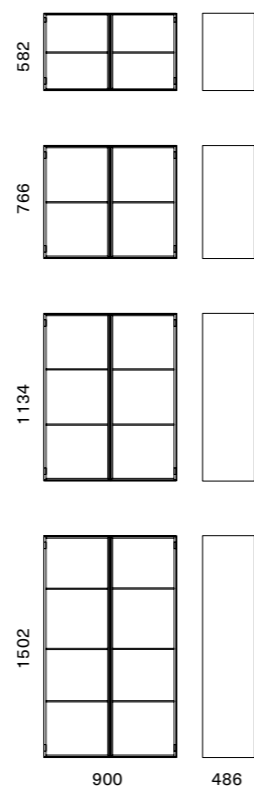

Finiture
Struttura laccato opaco Tufo, anta vetro Bronzato e telaio Brunito.

Finishes
Structure Tufo matt lacquered, Bronzato glass door and Brunito frame.

Dimensione - Dimensions
L 900 x H 1134 x P 480 mm

Codice - Code
L1K05012



Finiture
Struttura laccato opaco Tufo, ante vetro Trasparente e telaio Brunito.
Finishes
Structure Tufo matt lacquered, Trasparente glass door and Brunito
frame.

Dimensione - Dimensions
L 900 x H 766 x P 480 mm

Codice - Code
L1K05011



STREMA

Prezioso elemento d'appoggio o da parete creato da mani artigianali, dove dettagli come i fianchi rastremati e i cassettini in cuoio, fanno di Strema un complemento veramente importante per impreziosire un progetto d'arredo.

Precious support or wall element created by artisan hands, where details such as the tapered sides and leather drawers, make Strema a very important complement to embellish a furnishing design.

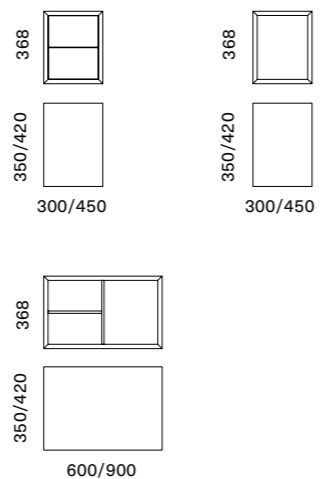

Finiture
Struttura folder frassino Ossidato, cassetti cuoio Brown.
Finishes
Folder Structure in Frassino Ossidato, leather Brown drawers.

Dimensione - Dimensions
L 300 x H 368 x P 420 mm
L 450 x H 368 x P 420 mm

Codice - Code
L1K04432
L1K04434



GRAFIC

Un sistema di librerie leggere, formate da una struttura metallica laccata in molteplici colori, contornata dai ripiani e schiene dalle diverse finiture a disposizione. Palette vivaci ed essenze del legno, fanno di Grafic un elemento d'arredo che permette combinazioni infinite.

A system of light bookcases, formed by a lacquered metal structure in multiple colours, surrounded by shelves and backs with different available finishes. Vivid colour ranges and wood essences make Grafic a piece of furniture that allows endless combinations.

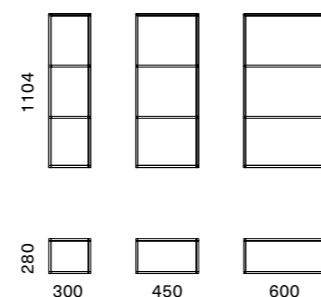
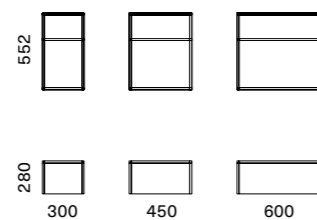
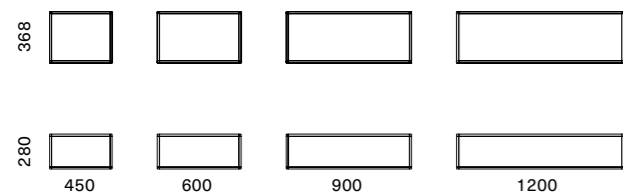

Finiture
 Telaio e ripiani laccato opaco Artico e laccato opaco Piombo.
 Telaio, ripiani e schiena laccato opaco Indaco.
 Telaio laccato opaco Artico, ripiani e schiena frassino Ossidato.

Finishes
 Artico matt lacquered frame and shelves, Piombo matt lacquered.
 Indaco matt lacquered frame, shelves and back.
 Artico matt lacquered frame, frassino Ossidato shelves and back.

Dimensione - Dimensions
 L 450 x H 368 x P 280 mm
 L 600 x H 552 x P 280 mm
 L 300 x H 1104 x P 280 mm

Codice - Code
 L1K04311
 L1K04326
 L1K04335





Finiture

Telaio e ripiani laccato opaco Artico e laccato opaco Piombo.

Telaio, ripiani e schiena laccato opaco Indaco.

Telaio laccato opaco Artico, ripiani e schiena frassino Ossidato.

Finishes

Artico matt lacquered frame and shelves, Piombo matt lacquered.

Indaco matt lacquered frame, shelves and back.

Artico matt lacquered frame, frassino Ossidato shelves and back.

Dimensione - Dimensions

L 450 x H 368 x P 280 mm

L 600 x H 552 x P 280 mm

L 300 x H 1104 x P 280 mm

L 450 x H 1104 x P 280 mm

Codice - Code

L1K04311

L1K04326

L1K04335

L1K04336

LANNY

Elemento metallico con schiena impiallacciata, laccata o materica, è posizionabile a piacimento in ogni spazio della casa. Il suo aspetto essenziale e la sua semplicità lo rendono un prodotto pensato per lasciare libertà nel disporre e valorizzare molteplici tipologie di oggetto.

Metal element with veneered, lacquered or textured back, can be positioned at will in every space of the house. Its essential appearance and its simplicity make it a product designed to allow freedom to arrange and enhance multiple types of objects.

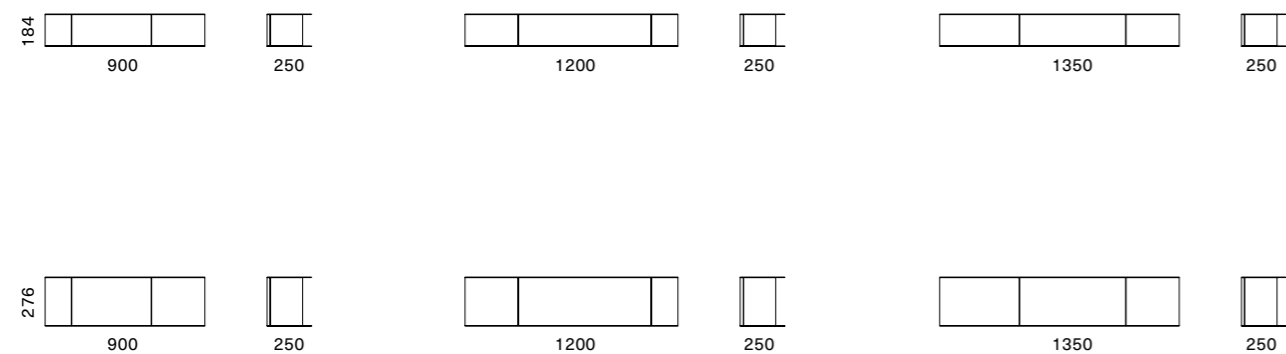

Finiture
Struttura laccato opaco Indaco, schiena frassino Ossidato.
Finishes
Indaco matt lacquered frame, frassino Ossidato back.

Dimensione - Dimensions
L 900 x H 276 x P 250 mm

Codice - Code
L1K04110





Finiture
Struttura laccato opaco Piuma, schiena frassino Carbone.
Finishes
Piuma matt lacquered frame, frassino Carbone back.

Dimensione - Dimensions
L 1350 x H 276 x P 250 mm

Codice - Code
L1K04114

ACCORDO

Quasi un abbraccio tra questo elemento e i contenitori sottostanti. La possibilità di creare emozioni di luce, grazie un LED perimetrale, si aggiunge alla sua funzione di servizio per riporre ed organizzare il quotidiano.

Almost an embrace between this element and the containers below. The possibility to create emotions of light, thanks to a perimeter LED, is added to its service function of storing and organising everyday life.

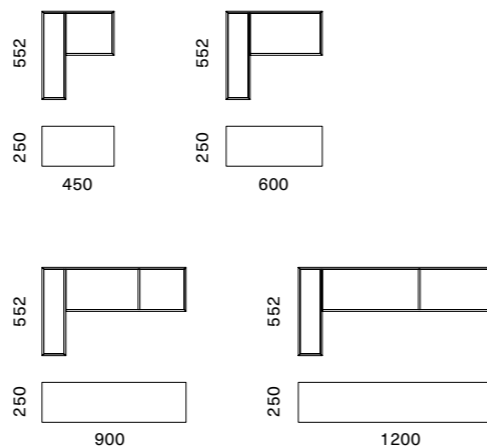

Finiture
Laccato opaco Ortensia.
Finishes
Ortensia matt lacquered.

Dimensione - Dimensions
L 1200 x H 552 x P 250 mm

Codice - Code
L1K00382



AIR

Con le diverse combinazioni di finiture tra scocca, schiena ed anta, si creano innumerevoli e affascinanti contrasti cromatici. Orizzontale o verticale, aperto o chiuso dall'antina scorrevole, l'elemento Air lascia grande libertà progettuale.

With the different combinations of finishes between the body, the back and the door, countless and fascinating colour contrasts are created. Horizontal or vertical, open or closed by the sliding door, the Air element leaves great design freedom.

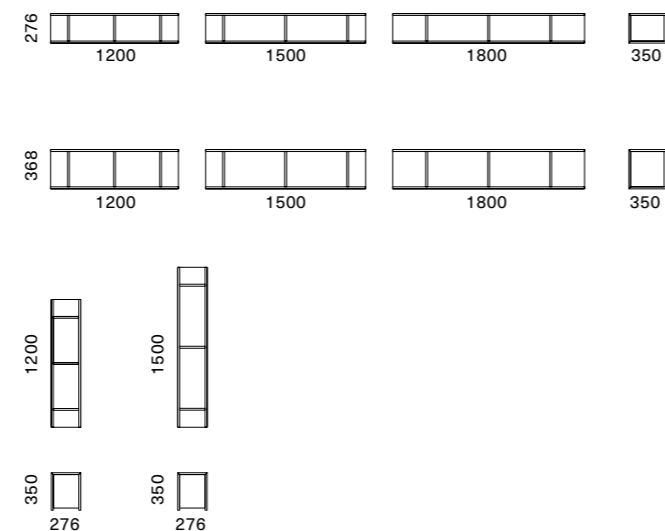

Finiture
Laccato opaco Piombo, laccato opaco Prugna e laccato opaco Ortensia. Laccato opaco Piombo con anta frassino Ossidato.
Finishes
Piombo matt lacquered, Prugna matt lacquered and Ortensia matt lacquered. Structure in Piombo matt lacquered with frassino Ossidato door.

Dimensione - Dimensions
L 276 x H 1200 x P 350 mm
L 276 x H 1500 x P 350 mm
L 1800 x H 368 x P 350 mm

Codice - Code
L1K04070
L1K04072
L1K04054



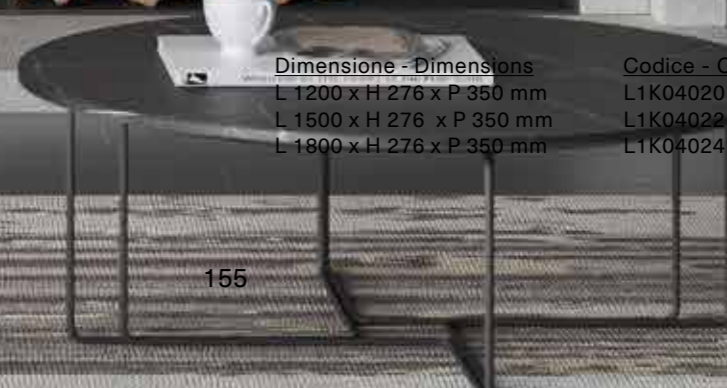

Finiture
Laccato opaco Cannella.
Laccato opaco Tufo.
Finishes
Cannella matt lacquered.
Tufo matt lacquered.

Dimensione - Dimensions
L 1200 x H 276 x P 350 mm
L 1500 x H 276 x P 350 mm
L 1800 x H 276 x P 350 mm

Codice - Code
L1K04020
L1K04022
L1K04024

UNIT

Lo dice il suo nome, due elementi uniti tra loro, davvero unici nella loro conformazione. Un design spiritoso adatto ad un pubblico che ama l'originalità e la dinamicità di un progetto.

Its name says it, two elements joined together, really unique in their shape. A witty design suitable for an audience that loves the originality and dynamism of a design.

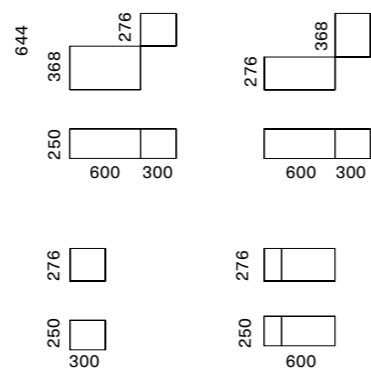

Finiture
Laccato opaco Muschio e laccato opaco Indaco.
Struttura laccato opaco Pino, schiena frassino Carbone.

Finishes
Muschio matt lacquered and Indaco matt lacquered.
Pino matt lacquered frame, frassino Carbone back.

Dimensione - Dimensions
L 900 x H 644 x P 250 mm

Codice - Code
L1K04144





Finiture
 Laccato opaco Indaco.
 Struttura laccato opaco Nebbia, schiena frassino Cuoio.
Finishes
 Indaco matt lacquered.
 Nebbia matt lacquered frame, frassino Cuoio back.

Dimensione - Dimensions
 L 300 x H 276 x P 250 mm L1K04140
 L 600 x H 276 x P 250 mm L1K04141

LULO

Specchio multifunzionale, corredato di un perimetro metallico disponibile in tutte le finiture laccato. Nel suo gioco di quadrati e rettangoli, racchiude degli appositi ganci utili per appendere indumenti d'uso quotidiano.

Multifunctional mirror, equipped with a metal perimeter available in all lacquered finishes. In its play of squares and rectangles, it contains special hooks useful for hanging clothes for everyday use.

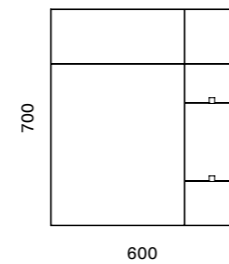

Finiture
Telaio laccato opaco Pino.
Finishes
Pino matt lacquered frame.

Dimensione - Dimensions
L 600 x H 700 mm

Codice - Code
L1S01570



LIME

Tre cerchi, con diametri diversi, uniti fra loro formano una composizione elegante e d'arredo. Grazie all'insero in metallo personalizzabile con le diverse finiture laccato, Lime oltre a specchiare ha la duplice funzione di servire come appenderia.

Three circles, with different diameters, joined together form an elegant and furnishing composition. Thanks to the customisable metal insert with the different lacquered finishes, Lime has the dual function of serving as a hanger in addition to mirroring.

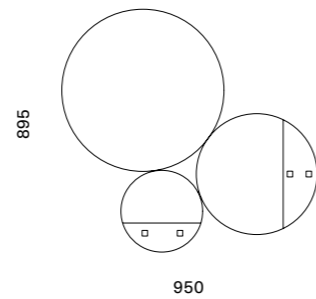

Finiture
Laccato opaco Fulvo.
Finishes
Fulvo matt lacquered.

Dimensione - Dimensions
L 950 x H 895 mm

Codice - Code
L1S01571



INFORMAZIONI TECNICHE

TECHNICAL DATA

FINITURE - FINISHES

MATERICO FINITURA LEGNO - WOOD FINISH TEXTURE

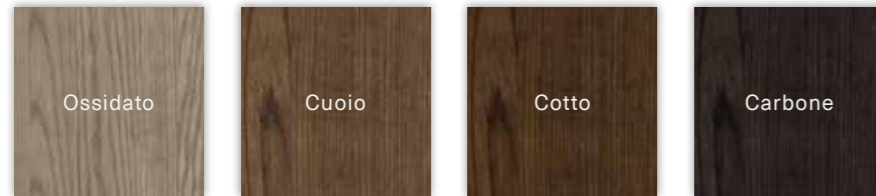

MATERICO COLORE OPACO - MATT COLOUR TEXTURE



IMPIALLACCIATI - VENEERED



CEMENTO - CEMENT

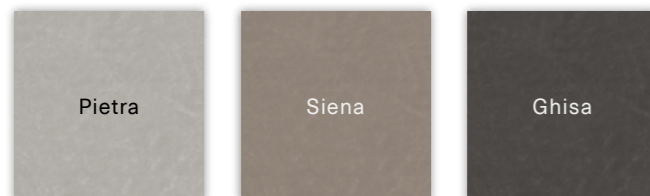

VETRI (sp.4mm) - GLASS (sp.4mm)

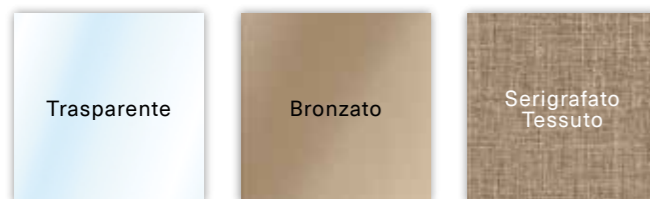

SPECCHI (sp.4mm) - MIRRORS (sp.4mm)

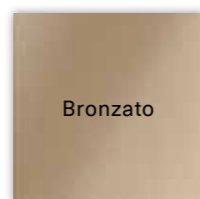

LACCATI OPACHI E LUCIDI - MATT AND GLOSSY LACQUERS

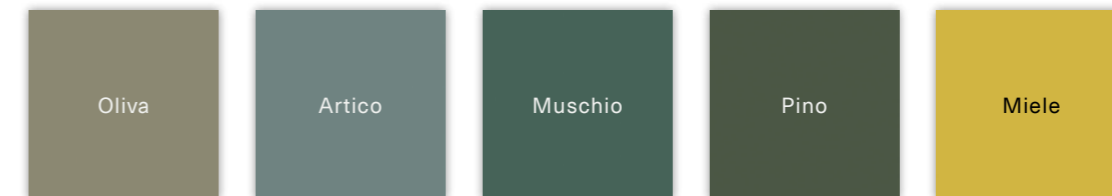

ROMBO LACCATO OPACO - MATT LACQUERED ROMBO

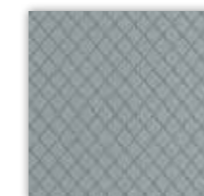

MARMI - MARBLE



TESSUTI - FABRICS

COLLEGE



LIBERTY



ECOPELLI - FAUX-LEATHER

NABUK



ECOPELLI VINTAGE



ECOPELLE
(solo per sedia Dafne
Dafne chair only)



MADIE - SIDEBOARDS

SYSTEM MODULO



Basamento: metallo finitura Brunito.
Struttura: Materico, Laccato opaco o lucido.
Frontali personalizzabili: anta Liscia e Virgo in Materico, Laccato opaco o lucido, Impiallacciato, Cemento; anta Rombo in Laccato opaco; anta Glass con vetro o pannello in Materico, Laccato opaco, Impiallacciato, Cemento.
Maniglie: Piolo, Tratto, Linea, Lateral, Push pull.
Top spess. 12mm: Materico, Laccato opaco o lucido, Impiallacciato, Marmo.

Base: Brunito finish metal.
Structure: Texture, matt or glossy Lacquered.
Customisable fronts: Liscia and Virgo Texture, matt or glossy Lacquered, Veneered, Cement door; matt Lacquered Rombo door; Glass door with Glass or Texture panel, matt Lacquered, Veneered, Cement.
Handles: Piolo, Tratto, Linea, Lateral, Push pull.
Top thickness 12mm: Texture, matt or glossy Lacquered, Veneered, Marble.

VIRGO



Basamento: metallo finitura Brunito.
Struttura: Materico, Laccato opaco o lucido.
Frontali personalizzabili: Materico, Laccato opaco, Impiallacciato, Cemento.
Maniglie: Laccato opaco.
Top spess. 12mm: Materico, Laccato opaco o lucido, Impiallacciato, Marmo.

Base: Brunito finish metal.
Structure: Texture, matt or glossy Lacquered.
Customisable fronts: Texture, matt Lacquered, Veneered, Cement door.
Handles: matt Lacquered.
Top thickness 12mm: Texture, matt or glossy Lacquered, Veneered, Marble.

ROMBO



Basamento: metallo finitura Brunito.
Struttura: Materico, Laccato opaco o lucido.
Frontali personalizzabili: anta Laccato opaco.
Maniglie: Push pull.
Top spess. 12mm: Materico, Laccato opaco, Marmo.

Base: Brunito finish metal.
Structure: Texture, matt or glossy Lacquered.
Customisable fronts: matt Lacquered door.
Handles: Push pull.
Top thickness 12mm: Texture, matt Lacquered, Marble.

GLASS



Basamento: metallo finitura Brunito.
Struttura: Materico, Laccato opaco o lucido.
Frontali personalizzabili: anta Glass con vetro o pannello in Materico, Laccato opaco, Impiallacciato, Cemento.
Top spess. 12mm: Materico, Laccato opaco o lucido, Impiallacciato, Marmo.

Base: Brunito finish metal.
Structure: Texture, matt or glossy Lacquered.
Customisable fronts: Glass door with Glass or Texture panel, matt Lacquered, Veneered, Cement.
Top thickness 12mm: Texture, matt or glossy Lacquered, Veneered, Marble.

TRAY



Basamento: metallo finitura Brunito.
Struttura: Materico, Laccato opaco o lucido.
Fianchi e schiena spess. 12mm: Materico, Laccato opaco o lucido.
Frontali personalizzabili: anta Liscia in Materico, Laccato opaco o lucido, Impiallacciato, Cemento; anta Rombo in Laccato opaco.
Maniglie: Tratto.
Top spess. 12mm: Materico, Laccato opaco o lucido, Impiallacciato, Marmo.

Base: Brunito finish metal.
Structure: Texture, matt or glossy Lacquered.
Side and back thickness 12mm: Texture, matt or glossy Lacquered.
Customisable fronts: Texture, matt or glossy Lacquered, Veneered, Cement Liscia door; matt Lacquered Rombo door.
Handles: Tratto.
Top thickness 12mm: Texture, matt or glossy Lacquered, Veneered, Marble.

CLIO



Struttura: Materico, Laccato opaco o lucido.
Fianchi e schiena spess. 18mm: Materico, Laccato opaco o lucido.
Frontali personalizzabili: anta Liscia in Materico, Laccato opaco o lucido, Impiallacciato, Cemento; anta Rombo in Laccato opaco.
Top spess. 12mm: Materico, Laccato opaco o lucido, Impiallacciato, Marmo.

Base: Brunito finish metal.
Structure: Texture, matt or glossy Lacquered.
Side and back thickness 18mm: Texture, matt or glossy Lacquered.
Customisable fronts: Texture, matt or glossy Lacquered, Veneered, Cement Liscia door; matt Lacquered Rombo door.
Top thickness 12mm: Texture, matt or glossy Lacquered, Veneered, Marble.

PUNTO 08



Basamento: metallo finitura Brunito.
Struttura: Materico, Laccato opaco o lucido.
Frontali personalizzabili: anta Liscia in Materico, Laccato opaco o lucido, Impiallacciato, Cemento; anta Rombo in Laccato opaco.
Maniglie: Linea.
Top e Fianchi spess. 8mm: Materico, Laccato opaco o lucido, Impiallacciato.

Base: Brunito finish metal.
Structure: Texture, matt or glossy Lacquered.
Customisable fronts: Texture, matt or glossy Lacquered, Veneered, Cement Liscia door; matt Lacquered Rombo door.
Handles: Linea.
Top and side thickness 8mm: Texture, matt or glossy Lacquered, Veneered.

LIBRERIE - BOOKCASES

WALL 12



Struttura: Laccato opaco.
Frontali personalizzabili: anta Liscia in Materico, Laccato opaco, Impiallacciato.
Maniglie: Push pull.

Structure: Texture, matt or glossy Lacquered.
Customisable fronts: Texture, matt Lacquered, Veneered Liscia door.
Handles: Push pull.

GRAFIC



Struttura: metallo profilo 15x15mm in Laccato opaco.
Ripiani e Schiena spess. 12mm: Materico, Laccato opaco, Impiallacciato, Cemento.

Frame: 15x15mm matt Lacquered metal profile.
Shelf and back thickness 12mm: Texture, matt Lacquer, Veneered, Cement.

TAVOLI - TABLES

SAMBUCO tavolo fisso - fixed table



Basamento: metallo finitura Brunito.
Piano ellittico: spess. 19 mm Laccato opaco; supporto Laccato opaco Tufo con piano spess. 31 mm Impiallacciato; supporto Laccato opaco Tufo con piano spess. 39 mm Marmo;
Piano squadrato: spess. 30 mm Materico; spess. 50 mm Impiallacciato.

Base: Brunito finish metal.
Elliptic top: thickness 19 mm matt Lacquered; Tufo matt Lacquered support with top thickness 31 mm Veneered; Tufo matt Lacquered support with top thickness 39 mm Marble.
Square top: thickness 30 mm Texture; thickness 50 mm Veneered.

PINO tavolo allungabile - extendible table



Struttura e Piano: Impiallacciato Frassino.
Structure and top: frassino Veneered.

SLIM tavolo fisso - fixed table



Struttura: metallo Laccato opaco.
Piano squadrato: spess. 12 mm Materico, Impiallacciato; spess. 20 mm Marmo.

Frame: matt Lacquered metal.
Square top: thickness 12 mm Texture, Veneered; thickness 12 mm Texture, Veneered; thickness 20 mm Marble.

LUIS tavolo fisso - fixed table



Struttura: metallo finitura Brunito.
Piano ellittico: spess. 19 mm Laccato opaco; supporto Laccato opaco Tufo con piano spess. 31 mm Impiallacciato; supporto Laccato opaco Tufo con piano spess. 39 mm Marmo;
Piano squadrato: spess. 30 mm Materico; spess. 50 mm Impiallacciato.

Base: Brunito finish metal.
Elliptic top: thickness 19 mm matt Lacquered; Tufo matt Lacquered support with top thickness 31 mm Veneered; Tufo matt Lacquered support with top thickness 39 mm Marble.
Square top: thickness 30 mm Texture; thickness 50 mm Veneered.

GLICINE



Struttura: metallo finitura Brunito.
Piano circolare: spess. 19 mm Laccato opaco; spess. 12 mm Impiallacciato; spess. 20 mm Marmo.

Base: Brunito finish metal.
Elliptic top: thickness 19 mm matt Lacquered; thickness 12 mm Veneered; thickness 20 mm Marble.

PUZZLE



Struttura: Materico, Laccato opaco.
Frontali personalizzati: anta Liscia in Materico, Laccato opaco.
Maniglia: Push pull.
Vassoio: Materico, Laccato Opaco.
Top spess. 12mm: Materico, Laccato Opaco, Marmo.

Structure: Texture, matt Lacquered.
Customisable fronts: Texture, matt Lacquered Liscia door.
Handle: Push pull.
Tray: Texture, matt Lacquered.
Top thickness 12mm: Texture, matt Lacquered, Marble.

TAVOLINI - OCCASIONAL TABLES

SAMBUCO



Struttura: metallo finitura Brunito.
Piano ellittico: spess. 19 mm Laccato opaco; spess. 12 mm Impiallacciato; spess. 20 mm Marmo.

Base: Brunito finish metal.
Elliptic top: thickness 19 mm matt Lacquered; thickness 12 mm Veneered; thickness 20 mm Marble.

GINESTRA



Struttura: metallo finitura Brunito.
Piano squadrato spess. 12 mm: Materico, Laccato opaco, Impiallacciato, Cemento.

Base: Brunito finish metal.
Square top thickness 12mm: Texture, matt Lacquered; Veneered, Cement.

SEDIE e POLTRONA - CHAIRS and ARMCHAIR

TETRIS sedia - chair



Struttura: impiallacciato Frassino.
Imbottitura: Tessuti, Ecopelli Vintage, ecopelle Nabuk.

Structure: frassino Veneered.
Padding: Fabric, Ecopelle Vintage, faux-leather Nabuk.

DAFNE sedia - chair



Struttura: Metallo.
Imbottitura: Ecopelli.

Structure: metal.
Padding: Ecopelle.

ASTER



Struttura: metallo finitura Brunito.
Piano circolare: spess. 19 mm Laccato opaco; spess. 12 mm Impiallacciato; spess. 20 mm Marmo.

Base: Brunito finish metal.
Circular top: thickness 19 mm matt Lacquered; thickness 12 mm Veneered; thickness 20 mm Marble.

FRUIT



Struttura: metallo Laccato opaco.
Piano circolare: spess. 19 mm Laccato opaco; spess. 12 mm Impiallacciato; spess. 20 mm Marmo.

Base: matt Lacquered metal.
Circular top: thickness 19 mm matt Lacquered; thickness 12 mm Veneered; thickness 20 mm Marble.

FANNY sedia - chair



Struttura: impiallacciato Frassino.
Imbottitura: Tessuti, Ecopelli Vintage, pelli Nabuk.

Structure: frassino Veneered.
Padding: Fabric, Ecopelle Vintage, faux-leather Nabuk.

TOSCA sedia - chair



Struttura: Metallo.
Imbottitura: Ecopelli Vintage, pelli Nabuk.

Structure: metal.
Padding: Ecopelle Vintage, faux-leather Nabuk.

AMARANTO



Struttura: metallo finitura Brunito.
Piano sagomato spess. 12 mm: Materico, Laccato opaco, Impiallacciato, Cemento.

Base: Brunito finish metal.
Shaped top thickness 12mm: Texture, matt Lacquered; Veneered, Cement.

LAMA



Struttura: metallo finitura Brunito.
Piano squadrato spess. 12 mm: Materico, Laccato opaco, Impiallacciato, Cemento.

Base: Brunito finish metal.
Square top thickness 12mm: Texture, matt Lacquered; Veneered, Cement.

DIAMANTE poltrona - armchair



Struttura: metallo finitura Brunito.
Imbottitura: Ecopelli Vintage, pelli Nabuk.

Structure: Brunito finish metal.
Padding: Ecopelle Vintage, faux-leather Nabuk.

COMPLEMENTI E ACCESSORI - COMPLEMENTS AND ACCESSORIES

ALFRED scrittoio - desk



Struttura: metallo finitura Brunito.
Piano spess. 30 mm: Materico, Laccato opaco.
Alzata: Materico, Laccato opaco.
Cassetti: Cuoio.
Base: Brunito finish metal.
Top thickness 30mm: Texture, matt Lacquered.
Riser: Texture, matt Lacquered.
Drawere: Leather.

TEKA pensile - wall unit



Struttura: Materico, Laccato opaco.
Frontali anta Glass: con vetro Trasparente, Bronzato, Serigrafato tessuto.
Structure: Texture, matt Lacquered.
Fronts Glass door: with Trasparente, Bronzato, Serigrafato tessuto glass.

STREMA pensile - wall unit



Struttura: Impiallacciato rastremato.
Cassetti: Cuoio.
Frame: scaped Veneered.
Drawers: Leather.

Grafic pensile - wall unit



Struttura 15x15 mm: metallo Laccato opaco.
Ripiani e Schiene: Materico, Laccato opaco, Impiallacciato, Cemento.
15x15 mm Frame: matt Lacquered metal.
Shelves and Backs: Texture, matt Lacquered, Veneered, Cement.

LANNY casellario - wall unit



Struttura: metallo Laccato opaco.
Schiena: Materico, Laccato opaco, Impiallacciato, Cemento.
Frame: matt Lacquered metal.
Back: Texture, matt Lacquered, Veneered, Cement.

ACCORDO casellario - wall unit



Struttura: Materico, Laccato opaco, Impiallacciato.
Structure: Texture, matt Lacquered, Veneered.

AIR casellario - wall unit



Struttura: Materico, Laccato opaco, Impiallacciato
Frontali: Materico, Laccato opaco, Impiallacciato.
Structure: Texture, matt Lacquered, Veneered.
Fronts: Texture, matt Lacquered, Veneered.

UNIT casellario - wall unit



Struttura: metallo Laccato opaco.
Schiena: Materico, Laccato opaco, Impiallacciato, Cemento.
Frame: matt Lacquered metal.
Back: Texture, matt Lacquered, Veneered, Cement.

LULO specchio - mirror



Struttura: metallo Laccato opaco.
Specchio: neutro.
Frame: matt Lacquered metal.
Mirror: Neutral.

LIME specchio - mirror



Struttura: metallo Laccato opaco.
Specchio: neutro.
Structure: matt Lacquered metal.
Mirror: Neutral.

Homes Casa s.r.l. si riserva di apportare in qualsiasi momento modifiche a prodotti, misure e materiali, che riterrà utile per esigenze di carattere produttivo e commerciale.
 Per essere sempre aggiornati vi invitiamo a consultare il nostro sito internet www.ormedesign.it.
 Le tonalità di colore e le finiture illustrate vanno considerate puramente indicative.
 Verificarne sempre la fattibilità dell'abbinamento finiture consultando il listino.

HOMES

UN GRUPPO, MOLTE RISPOSTE



AZIENDE DEL GRUPPO HOMES

SAN MICHELE
ORME
CLEVER
MISTRAL
NARDIINTERNI

ORME

Homes CASA Srl
Via Montello, 80
31053 – Pieve di Soligo
(TV) Italia

Servizio clienti Italia
t. +39 0438 984 581
f. +39 0438 984 589
e. orme@homes.it
w. ormedesign.it

Export Department
t. +39 0438 839 832
f. +39 0438 839 859
e. export@homes.it
w. homes.it

Homes S.p.a. – Headquarters
Via Montello, 63/1
31053 – Pieve di Soligo
(TV) Italia
t. +39 0438 9909 081
f. +39 0438 909 089
e. info@homes.it
w. homes.it



L1X00301

Copyright © Ottobre 2018 Homes Casa Srl / Orme



Il marchio della
gestione forestale
responsabile
Richiedi
i prodotti certificati

Design

Igino forlin inhouse design del gruppo homes
Haftenstudio

Art direction - Haftenstudio

Concept/set coordinator/ graphic - Haftenstudio

Virtual photography - Neiko s.r.l. - Pag 30/31 Nudesignstudio

Printed - Stampa AGCM (PN)

Printed in Italy 10. 2018 – 4500

